



**ENTRI**



# **CURRENT AFFAIRS**

## **MAGAZINE JULY-2023**

**Economy • Social Issues • Miscellaneous • Art and Culture**  
**Internal Security • International Relations • Environment & Ecology**  
**Polity and Governance • Science & Technology**

# ലക്ഷ്യമുണ്ടെങ്കിൽ മാർഗ്ഗവുമുണ്ട്.

**Entri യും Thakshasila യും കൈകോർക്കുന്നു.**

No.1 സിവിൽ സർവ്വീസ് കോച്ചിങ്ങ്. ഇനി വീട്ടിലിരുന്നു തന്നെ!

**Our  
CSE 2022  
Toppers**

<b>DILIP K KAINIKKARA (AIR 21)</b>	<b>ALFRED O V (AIR 57)</b>	<b>KIRAN P B (AIR 100)</b>	<b>ROJA S RAJAN (AIR 108)</b>	<b>ARJUN UNNIKRISHNAN (AIR 145)</b>		
<b>S GAUTHAMRAJ (AIR 210)</b>	<b>LALITH KUMAR V (AIR 211)</b>	<b>HRIDYA S VIJAYAN (AIR 317)</b>	<b>JOHN GEORGE DCOUTHU (AIR 428)</b>	<b>ANJALI BHAVANA (AIR 463)</b>	<b>APARNA O (AIR 475)</b>	<b>PRAPANJ R (AIR 523)</b>

**Our  
CSE 2021  
Toppers**

<b>APARNA M B (AIR 62)</b>	<b>VEENA S SUTHAN (AIR 57)</b>	<b>SOORAJ BEN K R (AIR 1)</b>				
<b>ARYA R NAIR (AIR 113)</b>	<b>MALINI S (AIR 135)</b>	<b>MINNU (AIR 150)</b>	<b>SREETHU S S (AIR 163)</b>	<b>THASNI SHANAVAS (AIR 250)</b>	<b>ALEX ABRAHAM P J (AIR 299)</b>	<b>ALFRED O V (AIR 310)</b>
<b>S GAUTHAMRAJ (AIR 311)</b>	<b>GOKUL S (AIR 357)</b>	<b>ANEEZ S (AIR 403)</b>	<b>HARIPRSAD K K (AIR 421)</b>	<b>SHWETA K SUGATHAN (AIR 456)</b>	<b>SABEEL POOVAKUNDIL (AIR 470)</b>	<b>AJESH (AIR 475)</b>

**Course features**

Delhi model intensive coaching | Live sessions | Study plan | Prelims test series  
 Writing practice for Mains | Special current affairs classes | Follow-up sessions  
 Doubt clearance | WhatsApp group | 600+ hours of recorded classes (Prelims/Mains)

**8137 095 777**

SCAN HERE

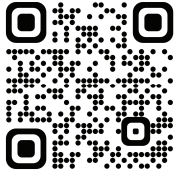

July- 2023

# Current Affairs

## Contents

Contents	Page No.
<b>ART AND CULTURE</b>	1-10
<ul style="list-style-type: none"><li>• Ahilyanagar</li><li>• Gandhi Peace Prize 2021</li><li>• Jagannath Rath Yatra</li><li>• Sahitya Akademi Awards</li><li>• Chhatrapati Shivaji Maharaj</li><li>• Ambubachi Mela</li><li>• Ancient Mayan city</li><li>• Mesolithic Rock painting</li><li>• Statue of Unity</li><li>• Al-Hakim Mosque</li><li>• Malcha Mahal</li><li>• Palkhi festival</li><li>• Gilgit Manuscripts</li><li>• Gulabi meenakari handicraft</li></ul>	
<b>POLITY &amp; GOVERNANCE</b>	11-20
<ul style="list-style-type: none"><li>• Sedition Law</li><li>• Adverse possession</li><li>• UGC guidelines</li><li>• Uniform Civil Code</li><li>• Inclusion of 80 Castes in OBC List by NCBC</li><li>• Right to Change One's Name and The Right To Life</li><li>• GRAI</li></ul>	
<b>ENVIRONMENT AND ECOLOGY</b>	21-35
<ul style="list-style-type: none"><li>• Earth System Boundaries (ESBs)</li><li>• National Working Plan Code-2023</li><li>• G20 agriculture ministers' meeting</li><li>• FAO</li><li>• Sundargarh Forest</li><li>• World's first treaty to protect the high seas</li><li>• Earthquakes</li><li>• LEED Zero</li><li>• Global Ocean Census</li><li>• Decarbonise</li><li>• Food safety index</li><li>• Vienna Declaration</li><li>• Asia Pacific Plant Protection Commission</li><li>• Hindu Kush Himalayas</li></ul>	

- Bonn Climate
- Auroras

## **ECONOMY**

36-49

- SEBI
- Arbitration Law
- Remittance
- TREDS
- PPIs
- Antardrishti
- Software-as-a-Service
- Crude Steel
- DLG
- Execution-only platform (EOP)
- South African Customs Union (SACU)
- About the South African Customs Union (SACU)
- Liberalised Remittances Scheme

## **SCIENCE AND TECHNOLOGY**

50-66

- Neuralink Chip
- United Nations New Policy
- Stars to become invisible
- Brain Electrical Oscillation Signature Profiling (BEOS)
- Antimicrobial Resistance (AMR)
- Mobile Satellite Service (MSS) terminals
- Solar Ultraviolet Imaging Telescope (SUIT)
- Synthetic human embryos
- Phonons
- Higgs boson
- Viruses
- MAHIR
- Vaccine for respiratory syncytial virus (RSV)
- Biodegradable Supercapacitor
- Einstein Telescope
- Chiral Bose-Liquid State
- Skin Bank

## **SOCIAL ISSUES**

67-76

- Human Organ/Tissue for Transplantation
- NGT
- Telegram Bots
- UNSDC Framework 2023-2027
- Sustainability Report
- Manual Scavenging
- Gender Gap Report, 2023
- Gender Social Norms Index (GSNI) 2023
- Global Slavery Index 2023

## **INTERNATIONAL RELATION**

77-92

- UN postal agency
- India and Nepal
- ICC arrest warrant
- 11th Edition of the World of Work Report
- Henley Private Wealth Migration Report 2023



- Armenia and Azerbaijan
- Global Fund for EV battery
- India and US
- Iran
- India and Suriname
- Northern Sea Route
- India and New Zealand
- Atlantic Declaration
- Developing Nation Status Act
- Bangkok Vision 2030
- NATO Plus grouping
- Heliopolis Memorial
- Artemis Accords
- Order of the Nile award

### **GOVERNMENT SCHEME**

**93-100**

- World's Largest Grain Storage Plan in Cooperative Sector
- CITIIS 2.0
- Dugdh Sankalan Sathi Mobile App
- Nyaya Vikas Portal
- Pradhan Mantri Bhartiya Janaushadhi Pariyojana (PMBJP)
- VAIBHAV fellowships Programme
- SANKALP Programme
- PM Matru Vandana Yojana
- Poshan Tracker App

### **MISCELLANEOUS**

**101-109**

- ERSO
- National Electricity Plan
- TAPAS UAV
- Child Trafficking in India
- India Rankings 2023
- Research & Analysis Wing (RAW)
- Operation Amanat
- Mineral Security Partnership
- Global Liveability Index 2023
- Nano Urea
- National Florence Nightingale Awards

### **Yojana June 2023: Gifting Holistic Well-being to the World**

**110-116**

- Chapter 1: AYUSH
- Chapter 2: Yoga for Global Well-being
- Chapter 3: Role of Meditative Approaches in Mental Well-Being
- Chapter 4: Basics of Healthy Lifestyle
- Chapter 5: Non-Possession – The Gandhian Thought

### **Kurukshetra June 2023: Water Conservation**

**117-127**

- Chapter 1: Fostering Water Management for Food Security
- Chapter 2: Water Conservation through Community Planning
- Chapter 3: Community Engagement in MGNREGA Watershed Development Works
- Chapter 4: Making Villages Water Sufficient
- Chapter 5: Water Use Efficiency Ensuring Water Sustainability
- Chapter 6: 2023: Year of International Water Commitments and What it Means for Rural India

# Chapter- 1

## ART AND CULTURE

### Ahilyanagar

#### Why in News

Maharashtra government has decided to rename Ahmednagar district as Ahilyanagar.

#### Important Points

- In yet another name-changing move in the BJP-ruled states, the Maharashtra government has decided to rename Ahmednagar district as Ahilyadevi Nagar after Maratha ruler Maharani Ahilyabai Holkar.
- Chief minister of Maharashtra made the announcement during the 298th birth anniversary celebrations of the hereditary noble queen of the Maratha Empire in Malwa.
- Ahilyabai worked for the welfare of people from all strata in the society. She set an example for good governance and administration.
- The renaming of Ahmednagar was the latest name-changing move taken by the government, which had renamed Maharashtra's Aurangabad and Osmanabad districts as Chhatrapati Sambhaji Nagar and Dharashiv respectively.

#### About Ahilyabai Holkar (1725 – 1795)

- She was the Holkar Queen of the Maratha Malwa kingdom, India.
- Ahilyabai was born in the village of Chondi in Jamkhed, Ahmednagar, Maharashtra.
- She moved the capital to Maheshwar south of Indore on the Narmada River.
- Ahilyabai's husband Khanderao Holkar was killed in the battle of Kumbher in 1754.
- Twelve years later, her father-in-law, Malhar Rao Holkar, died. A year after that she was crowned as the queen of the Malwa kingdom.
- She tried to protect her kingdom from plundering invaders. She personally led armies into battle. She appointed Tukojirao Holkar as the Chief of Army.
- Ahilyabai was a great pioneer and builder of Hindu temples. She built hundreds of temples and Dharmashalas throughout India.
- She was born on 31 May 1725 in the village of Chaundi, in the present-day Ahmednagar district in Maharashtra.
- Her father, Mankoji Rao Shinde, was the Patil of the village. Women then did not go to school, but Ahilyabai's father taught her to read and write.
- She excelled at administrative and military strategies and during her rule perfect order and good government prevailed.
- City of Maheshwar became a literary, musical, artistic and industrial centre, and she helped establish a textile industry there, which is now home to famous Maheshwari saris.
- She focused on restoration/revamp of various temples including Kashi Vishwanath, Badrinath, Dwarka, Omkareshwari etc.



### Gandhi Peace Prize 2021

#### Why in News

Gita Press, Gorakhpur, awarded Gandhi Peace Prize for 2021.

#### Important Points

- Gandhi Peace Prize is an annual award instituted by Government of India in 1995, on the occasion of 125th Birth Anniversary of Mahatma Gandhi as a tribute to the ideals espoused by Mahatma Gandhi.

- The award is open to all persons regardless of nationality, race, language, caste, creed or gender.
- The award carries an amount of Rs. 1 crore, a citation, a plaque and an exquisite traditional handicraft/ handloom item.
- The Congress, however, criticised awarding the prize to Gita Press and called it a “travesty”.

### Gita Press

- Gorakhpur as the recipient of the Gandhi Peace Prize for the year 2021, in recognition of its outstanding contribution towards social, economic and political transformation through non-violent and other Gandhian methods.
- Established in 1923, Gita Press is one of the world’s largest publishers, having published 41.7 crore books in 14 languages, including 16.21 crore Shrimad Bhagvad Gita.
- The institution has never relied on advertisement in its publications, for revenue generation.
- Gita Press along with its affiliated organizations, strives for the betterment of life and the well being of all.
- Prime Minister recalled the contribution of Gita Press, in promoting the Gandhian ideals of peace and social harmony.
- He observed that the conferment of Gandhi Peace Prize on Gita Press, on completion of hundred years of its establishment, is a recognition of the work done by the institution in community service.
- Gandhi Peace Prize 2021, recognizes the important and unparalleled contribution of Gita Press, in contributing to collective upliftment of humanity, which personifies Gandhian living in true sense.
- Past awardees include organisations such as ISRO and Ramakrishna Mission



## Jagannath Rath Yatra

### Why in News

Jagannath Rath Yatra to began from 20 June 2023.

### Important Points

- The Ratha Yatra of Puri, popularly known as Ratha Jatra is the oldest and largest Hindu chariot festival.
- It celebrates Lord Jagannath and his siblings annually, on the bright half of the lunar month of Ashadh (June-July).
- This ancient tradition of chariot procession is held with great joy and pomp in Odisha and Ahmedabad.
- The resonating sound of the conch shells elevates the synchronized music of the drums and bells with the chanting steadily rising in tempo and faith; the god is brought out of the temple.
- Lord Jagannath, the reincarnation of the notorious Lord Krishna resides in the temple town of Puri along the Bay of Bengal in Bhubaneswar, Orissa.
- According to a popular legend, Lord Jagannath desired to visit his birthplace Mathura once every year along with his brother Lord Balabhadra and sister Goddess Subhadra to show her Mathura on a chariot.
- This Journey from the Jagannath Temple in Puri to Gundichi Devi Temple in Mathura is known as the Jagannath Puri Rath Yatra.
- Every year, the three deities are carried on chariots few miles away to Gundicha Temple on the second day of the new moon in the month of Ashada (June-July) according to the Hindu calendar.

### Mysterious facts related to the Rath Yatra

#### 1. Waving Against the Wind

- The flag on the top of Jagannath temple flies opposite the wind. This is usually considered an act of the divine and science calls it the phenomenon of Karman Vortex Street in fluid dynamics. It may not be the case always but is possible most of the time, due to sea wind moving along the shikhara may lead to the formation of eddies. And these eddies near the top are the reason for the occasional reverse flying of the flag or Bana.



## 2. Nilachakra

- The 20 feet colossal chakra installed at the top of the temple 2000 years ago is visible from all the nooks and corners of the city. The design of the temple is still a mystery to many. It is believed that the Chakra upright at the highest point of the temple is 20 feet in height and weighs a ton. But the real mystery is the installation, like what energy helped the humans to climb up the 45-storey building with the weight of an elephant.

## 3. No Sound of Sea

- According to the Puranas, it is said that Lord Jagannath has entrusted the responsibility of protecting this temple to Lord Hanuman. Under this, Hanumana stopped the sound of the ocean from coming inside this temple, so Lord Jagannath can sleep without any disturbance.
- And as per scientific explanation, the temple is a closed structure barricaded by tall stone walls. Even the noise emanating from just outside the temple is not audible inside the temple. So there is no way the sound of the sea waves can be heard inside the temple.

## 4. No Fly Zone

- People are usually amazed by the fact that no birds or planes are seen flying above the temple. Believed as a divine act, the scientific reason no birds fly over the temple is possibly the cylindrical structure of the building. It is believed that the density of air is lower due to more humidity and the Reynolds No is also directly proportional to the velocity of air, which tends to be more near the sea. And this condition does seem favourable for creatures to fly.
- On the other hand, it is said there are no flying routes for planes that go above the temple. And, the airspace above the temple has been declared as a 'No Fly Zone'.

## 5. No Shadow

- It shines or rain, no one has ever seen the shadow of the grand temple of Jagannath Puri. The main dome's shadow cannot ever be seen because of the architectural prowess of our yesteryear engineers. According to the principles of science, the shadow of the dome always falls on the building itself and hence it is invisible to everybody.

## 6. No Wastage Policy

- Jagannath Puri temple serves every day around 2000 to 20,00,000 devotees every day. 'Amunia', a kind of special rice is used to cook 'anna' which is served as part of prasadam. And with no scientific explanation, it is true that none of the individuals goes without prasadam from the temple premises.

## 7. Magical Pot

- The Mahaprasad at Jagannath temple is cooked in a unique style, with 7 clay pots one over the other. According to science, the prasad in the first pot gets cooked first because of the difference in pressure on the top of each pot. As the boiling point of a liquid is directly proportional to the pressure on that liquid.

## 8. Wooden Idols

- During Nabakalebara, new wooden idols of deities replace the old ones. The ritual is performed once every 8, 12, or 19 years. Artisans pick specific sacred neem trees to carve out the idols of Lord Jagannath and his siblings Mata Subhadra and brother Balbhadrabrama. Millions of worshippers watched the last Nabakalebara, which took place in 2015.

## Sahitya Akademi Awards

### Why in News

Sahitya Akademi members to oppose government's intrusion in literary awards

### Important Points

- The Union Ministry of Culture recently expressed its intent to change the process of nomination for the prestigious Sahitya Akademi Award, given to writers in 24 languages, as well as its plan to consolidate awards bestowed upon writers for children and youth into a single category.
- In a letter issued to the Akademi, the government has suggested that in the new format any writer can nominate himself or herself and also recommend other candidates for the awards.
- This has created a stir within the literary community, with many insisting that the government's move translates into direct meddling in the institution's work.
- In addition, if this goes unopposed, chances are it may be replicated in similar institutions across the country, they fear.



- The ministry has asked the Akademi to respond to its notice issued after internal consultation with committee members. The members will convene to discuss the government's move and Akademi members will put down their concerns in a letter after the meeting.

### About Sahitya Akademi Awards

- The Sahitya Akademi Awards, bestowed annually.
- It aims to preserve the country's literary heritage, and encourage independent and translated literary production.
- It honours the contributions of writers in various regional languages.
- With four awards for each language, the Akademi plays a crucial role in recognising excellence in literature.
- The selection process for the main award, known as the Bhasha Samman, is conducted through a rigorous and confidential process overseen by experts – the body comprises one writer chosen from each of the 24 regional languages.



### Selection Procedure

- A member of the Akademi's general council explained the rigorous process of selection, which he fears stands to be compromised in future.
- Each member suggests 200 names, following which an expert committee finalizes 50 in phase one.
- This lot goes through another round of scrutiny, and five names are shortlisted.
- Two confidential juries then pick out one of the five as the finalist.

### Fear of Political Interference

- With the open nomination process, there is likely to be an interference from the political leaders that will distract the qualitative work of the Akademi.
- Approximately, 80 members representing the 24 languages will discuss the government's notice.

## Chhatrapati Shivaji Maharaj

### Why in News

Mega 350th coronation anniversary of Chhatrapati Shivaji Maharaj at Raigad

### Important Points

- Government of India paid homage to Chhatrapati Shivaji Maharaj as Maharashtra celebrates the 350th Coronation anniversary of the Maratha warrior king.
- Shivaji Maharaj is a beacon of courage and bravery and his ideals are a source of great inspiration.
- The basic principle of Shivaji Maharaj was welfare of the state and its people.

### Coronation of Chhatrapati Shivaji Maharaj

- The coronation of Shivaji Maharaj was conducted on June 6, 1974 at Raigad fort on the 13th day (trayodashi) of the first fortnight of the month of Jyeshtha.
- The ceremony was conducted as per the shastras by Vishweshwar or Gaga Bhatta of Varanasi.
- The grand coronation ceremony started with the break of dawn. About Chhatrapati Shivaji Maharaj
- Chhatrapati Shivaji Maharaj was the founder of the Maratha Empire in western India.
- Shivaji Bhosle was born on February 19, 1630 to Shahaji Bhosle and Jijabai in the fort of Shivneri, near the city of Junnar of the Pune district.
- Shivaji's father Shahaji was in service of the Bijapuri Sultanate - a tripartite association between Bijapur, Ahmednagar, and Golconda, as a general. He also owned a Jaigirdari near Pune.
- Shivaji's mother Jijabai was the daughter of Sindkhed leader Lakhujirao Jadhav and a deeply religious woman
- Shivaji is considered to be one of the greatest warriors of his time and even today, stories of his exploits are narrated as a part of the folklore.
- With his valor and great administrative skills, Shivaji carved out an enclave from the declining Adilshahi sultanate of Bijapur.



- It eventually became the genesis of the Maratha Empire.
- After establishing his rule, Shivaji implemented a competent and progressive administration with the help of a disciplined military and well-established administrative set-up.
- Shivaji is well-known for his innovative military tactics that centered around non-conventional methods leveraging strategic factors like geography, speed, and surprise to defeat his more powerful enemies.
- Shivaji's conflicts with the Bijapuri Sultanate and his continuous victories brought him under the radar of Mughal Emperor Aurangzeb.
- Shivaji died at the age of 52 on April 3, 1680, at the Raigad Fort, after suffering from a bout of dysentery.

### Administration

- Under his reign, the Maratha administration was established where Chhatrapati was the supreme sovereign and a team of eight ministers were appointed to oversee the proper enforcement of various policies.
- These eight ministers reported directly to Shivaji and were given a lot of power in terms of execution of policies formulated by the King. These eight ministers were –
  1. The Peshwa or Prime Minister, who was head of general administration and represented the king in his absence.
  2. The Majumdar or the Auditor was responsible for maintaining the financial health of the kingdom.
  3. The Pandit Rao or Chief Spiritual Head was responsible for overseeing the spiritual well-being of the kingdom, fixing dates for religious ceremonies and overseeing charitable programs undertaken by the king.
  4. The Dabir or Foreign Secretary was entrusted with the responsibility of advising the king on matters of foreign policies.
  5. The Senapati or Military General was in charge of overseeing every aspect of the military including organization, recruitment and training of soldiers. He also was the strategic advisor of the king in the time of a war.
  6. The Nyayadhish or Chief Justice saw formulations of law and their subsequent enforcement, civil, judicial as well as military.
  7. The Mantri or Chronicler was responsible for keeping elaborate records of everything the king did in his daily life.
  8. The Sachiv or Superintendent was in charge of royal correspondence.

## Ambubachi Mela

### Why in News

Three temporary camps with adequate security arrangements were recently set up for devotees and tourists coming to the Kamakhya temple for the Ambubachi Mela.

### Important Points

#### Ambubachi Mela:

- It is an annual Hindu fair held at the historic Kamakhya Temple.
- It is celebrated during the monsoon season that happens to fall during the Assamese month Ahaan, around the middle of June.
- It is the celebration of the yearly menstruation course of goddess Maa Kamakhya.
- This mela is also known as Ameti or Tantric fertility festival since it is closely associated with Tantric Shakti cult prevalent in eastern parts of India.

#### Kamakhya temple:

- It is situated on Nilachal Hill and adjoining the southern bank of the Brahmaputra River in Guwahati,
- It is one of the most revered centres of Tantric practices.
- It is regarded as one of the oldest of the 51 Shakti Peethas in India.



#### Architecture:

- It had been modelled out of a combination of two different styles namely, the traditional nagara or North Indian and Saracenic or Mughal style of architecture.
- This unusual combination has been named the Nilachala Style of Architecture.
- This is the only temple of Assam having a fully developed ground plan.

- It consists of five chambers, garbhagriha or sanctuary, antarala or vestibule, Jagan Mohan or principal chamber, bhogmandir or ritual chamber and natmandir or opera hall for performing traditional dance and music associated with sukta temples.
- It is interesting to note that the superstructure of each of the above chambers exhibits different architectural features.
- While the main temple contains a modified Saracenic dome, the antarala carries a two-roofed design, the bhogmandir (also called pancharatna) with five domes similar in appearance to the main temple and the natmandir having a shell-roof with apsidal end similar to some of the impermanent namghars or prayer halls found in Assam.

## Ancient Mayan city

### Why in News

Recently, a previously unknown ancient Mayan city has been discovered in the jungles of southern Mexico by anthropologists.

### Important Points

#### Ancient Maya city

- A previously unknown ancient Maya city has been discovered in the jungles of southern Mexico, adding it was likely an important center more than a thousand years ago.
- The city includes large pyramid-like buildings, stone columns, three plazas with “imposing buildings” and other structures arranged in almost-concentric circles.
- It is located in the Balamku ecological reserve on the country’s Yucatan Peninsula.
- This city has been named Ocomtun - meaning “stone column” in the Yucatec Maya language.
- This would have been an important centre for the peninsula’s central lowland region between 250 and 1000 AD.
- It has a core area located on high ground surrounded by extensive wetlands.

#### Mayan Civilization

- The Mayans are probably the best-known of the classical civilizations of Mesoamerica.
- Originating in the Yucatán peninsula around 2600 B.C., they rose to prominence around A.D. 250 in present-day southern Mexico, Guatemala, northern Belize and western Honduras.
- Building on the inherited inventions and ideas of earlier civilizations, the Maya developed astronomy, calendrical systems and hieroglyphic writing.
- They were also noted for elaborate and highly decorated ceremonial architecture, including temple pyramids, palaces and observatories, all built without metal tools.
- They were also skilled farmers, clearing large sections of tropical rainforest and, where groundwater was scarce, building sizable underground reservoirs for the storage of rainwater.



#### Where is Yucatan Peninsula?

- It is a Northeastern projection of Central America which is lying between the Gulf of Mexico to the west and north and the Caribbean Sea to the east.
- The peninsula is almost wholly composed of beds of coralline and porous limestone rocks.

## Mesolithic Rock painting

### Why in News

Recently, a Mesolithic period rock painting depicting a person tilling a piece of land has been found in Orvakallu village in Guntur district, Andhra Pradesh.

### Important Points

- The paintings were made with “natural white kaolin and red ochre pigments”,
- Ochre is a pigment composed of clay, sand, and ferric oxide.



- Kaolinite is a soft, earthy, and usually white mineral produced by the chemical weathering of aluminum silicate minerals like feldspar.
- These paintings throw light on aspects of the social life and culture of the people who lived in the area.
- One of the paintings depicted a man catching a wild goat with his left hand while wielding a hook-like implement to control it.
- Another showed two couples standing with their hands raised while a child stood behind them.

### Mesolithic period

- It is also called Middle Stone Age which existed between the Paleolithic (Old Stone Age) and the Neolithic (New Stone Age).
- Timeframe: This period is generally considered to have occurred between approximately 12,000-10,000 years ago
- Lifestyle: During the Mesolithic period, human societies were predominantly hunter-gatherer communities.
- People relied on hunting, fishing, and gathering wild plant resources for their sustenance.
- Stone tools found during this period are generally tiny, and are called microliths.
- Microliths were probably stuck onto handles of bone or wood to make tools such as saws and sickles.
- At the same time, older varieties of tools continued to be in use.

## Statue of Unity

### Why in News

The Statue of Unity Area Development and Tourism Governance Authority (SOUADTGA) recently issued a tender to resume the suspended helicopter joyride services at the Statue of Unity.

### Important Points

- The statue was built to honor Sardar Vallabhbhai Patel, also known as the ‘Iron Man of India.’
- Situated in Gujarat, on the banks of the Narmada River, on the River Island of Sadhu Bet, overlooking the Narmada Dam.
- Standing at a height of 182 meters, the statue is recognized as the tallest in the world, surpassing the height of China’s Spring Temple Buddha by 177 feet.
- Indian construction company Larsen & Toubro (L&T) undertook the construction of the statue, while the design was created by renowned sculptor Ram V Sutar, a recipient of the Padma Bhushan award.

### Sardar Vallabhbhai Patel:

- Vallabhbhai Jhaverbhai Patel, known as Sardar Patel, was born on 31st October 1875 in Nadiad, Gujarat.
- He was an Indian barrister and statesman, and one of the prominent leaders of the Indian National Congress during the struggle for Indian independence.
- In 1918, Patel gained recognition for organizing mass campaigns against the Bombay government’s decision to collect full annual revenue taxes despite crop failures caused by heavy rains in Kaira, Gujarat.
- He embraced Mahatma Gandhi’s ideas and actively participated in the non-cooperation movement in 1920, adopting indigenous Khadi items and boycotting foreign clothes.
- Patel led the Satyagraha movement in Nagpur in 1923, protesting against the British law that banned the hoisting of the Indian Flag.
- In 1928, he successfully led the landowners of Bardoli in their resistance against increased taxes, earning him the title of “sardar” or leader.
- Patel was appointed as the first Deputy Prime Minister and Home Minister of India from 1947 to 1950.
- He played a crucial role in the integration of numerous Indian princely states, aiming to forge a united India from over 560 semi-autonomous princely states and British-era colonial provinces.
- Through frank diplomacy and, if necessary, military action, Patel’s leadership enabled the accession of almost every princely state, making him the real unifier of India.

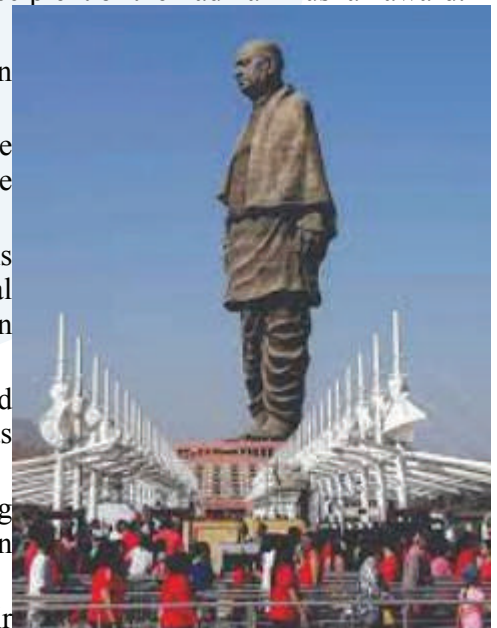

- He is remembered as the “Patron saint of India’s civil servants” for establishing the modern all-India services system and is widely hailed as the Iron Man of India.
- Patel held important positions in the Constituent Assembly of India, including the Provincial Constitution Committee and the Advisory Committee on Fundamental Rights, Minorities, and Tribal and Excluded Areas.

#### Recognition:

- Since 2014, Rashtriya Ekta Diwas or National Unity Day is observed on 31st October each year to pay tribute to Sardar Vallabhbhai Patel, who played a pivotal role in India’s freedom struggle and the integration of the country.
- He was posthumously awarded the Bharat Ratna, India’s highest civilian honor, in 1991, in recognition of his significant contributions.

## Al-Hakim Mosque

### Why in News

Indian Prime Minister will visit the 11th Century Al-Hakim mosque, restored with the help of the Dawoodi Bohra community, during his first visit to Egypt.

### Important Points

- It is a historical mosque located in Cairo, Egypt.
- It is named after Al-Hakim bi-Amr Allah (985–1021 AD), the sixth Fatimid caliph.
- The mosque was originally built by the Fatimid vizier Gawhar Al-Siqilli, but was incorporated into the extended fortifications built by Badr al-Jamali at the end of the 11th century AD.
- The mosque was inscribed as a UNESCO World Heritage Site in 1979.

### Architecture:

- The mosque is constructed of brick with stone facades and minarets.
- The plan of the mosque consists of a triangle with four arcades centering a courtyard. Two minarets flank either side of the façade.
- Originally built outside Cairo’s northern wall, the mosque was incorporated within the city in 1087, transforming its own northern wall and minarets into an integral part of the fortifications.
- The main entrance lies on the western facade of the mosque and is monumental in size and design. It is one of the oldest architectural examples of projecting entrances.



### About Dawoodi Bohra community

- Dawoodi Bohra community is a sect within Shia Islam known for trading and business acumen.
- India is known to have around 500,000 Bohras, including the diasporas spread across the world.
- A large number of the Dawoodi Bohra population reside in India, Yemen, Pakistan and East Africa.
- The Dawoodi Bohras also regard the Quran as the word of Allah as revealed to Prophet Mohammed al-Mustafa, and their lives revolve around its teachings.
- The Dawoodi Bohras throughout the world are guided by their leader, known as the al-dai al-mutlaq (unrestricted missionary), who first operated from Yemen and then, for the last 450 years, from India.

## Malcha Mahal

### Why in News

The area around Malcha Mahal is all set to get a facelift, as the lieutenant governor recently asked the authorities to carry out a five-layered plantation of various flowering trees in it.

### Important Points

- It is a Tughlaq-era hunting lodge, built by Feroz Shah Tughlaq in the 14th century.
- It is located in Chanakyapuri area of New Delhi.
- It came to be known as Wilayat Mahal after Begum Wilayat Mahal of Awadh, who was reportedly given the place by the government of India in May 1985.

- For over three decades, it served as home to the family of Begum Wilayat Mahal, claiming to be descendants of the Nawab of Awadh, whose last member, ‘Prince’ Ali Raza, died in 2017.

#### About Feroz Shah Tughlaq:

- Born in 1309, Firoz Shah Tughlaq was the third ruler of the Tughlaq dynasty that ruled over Delhi from 1320 to 1412 AD.
- He was in power from 1351 to 1388 AD.
- He ascended the throne after the death of his cousin Muhammad-bin Tughlaq (ruled from 1324 to 1351 AD).

#### Firoz Shah Tughlaq Rule:

- His succession was faced with many rebellions, and due to widespread unrest, his realm was much smaller than Muhammad’s.
- During his rule, Firoz Shah worked to improve the infrastructure of the empire. He did this by building canals, rest- houses and hospitals, creating and refurbishing reservoirs and digging wells.
- He also founded several cities around Delhi, including Jaunpur, Firozpur, Hissar, Firozabad and Fatehabad.
- He also repaired the Qutub Minar, which had been damaged by an earthquake.
- He wrote his own autobiography called the ‘Futuh-e-Firozshahi’.
- Firoz Shah was indiscriminately benevolent and lenient as a ruler. He refused to re-conquer provinces that had broken away from Muhammad’s annexation.
- He stopped all kinds of harsh punishments, such as cutting off hands, and lowered the land taxes that Muhammad had raised.
- He sought advice from the Ulemas and ruled as per the Shariat. He imposed a number of taxes like the Kharaj, Zakat, Kham and Jaziya, which were levied on the non-Muslim subjects. He also imposed an irrigation tax after getting it sanctioned from the Ulema.
- He provided the principle of inheritance to the armed forces, where the officers were permitted to rest and send their children into the army in their place.
- He established the Diwan-i-Khairat -- office for charity.
- He established the Diwan-i-Bundagan -- department of slaves.
- He established Sarais (rest house) for the benefits of merchants and other travelers.
- He adopted the Iqtadari framework.



## Palkhi festival

### Why in news

Delegates from several countries, who are in the city for the G20 Digital Economy Working Group Conference, got a glimpse of the 800-year-old Warkari community’s palkhi festival.

### Important Points

- Palkhi is a 1000 — year old tradition which was started by some saints of Maharashtra (India) and is still continued by their followers called varkaris (people who follow a vari, a fundamental ritual).
- It is an annual pilgrimage (yatra) to Pandharpur - the seat of the Hindu god Vithoba in Maharashtra, in honour of the deity.

### Journey:

- They walk with palkhis (chariots) carrying paduka (sandals) of various saints - most notably Dnyaneshwar and Tukaram.
- Dnyaneshwar’s palakhi leaves from Alandi, while Tukaram’s begins at Dehu, both in Pune district of Maharashtra.
- The Palkhi starts in the month of Jyeshth (June), and the whole process lasts a total of 22 days.





- Every year on the eleventh day of the first half of the month of Ashadh, the Palkhi reaches Pandharpur.
- Upon reaching Pandharpur on Ashadi Ekadashi, these devotees take a holy dip in the sacred Chandrabhaga River/Bhima River before proceeding to visit the Vitthal temple.

### History:

- Every saint, right from Sant Dnyaneshwar to Sant Tukaram, was following the Vari tradition.
- In the year 1685, Narayan Baba, the youngest son of Tukaram was a man of innovative spirit and decided to bring about a change in the dindi-wari tradition by introducing the Palkhi, which is a sign of social respect.
- He put the silver padukas (footsteps) of Tukaram in the Palkhi and proceeded with his dindi to Alandi where he put the padukas of Dnyaneshwar in the same Palkhi.
- This tradition of twin Palkhis went on every year, but in 1830 there were some disputes in the family of Tukaram, concerned with rights and privileges.
- Following this, some thoughtful persons decided to break-up the tradition of twin Palkhis and organise here after, two separate Palkhis Tukaram Palkhi from Dehu (Pune) and the Dnyaneshwar Palkhi from Alandi (Pune).
- From that time till date, both the Palkhis meet in Pune for a brief halt and then diverge at Hadapsar to meet again at Wakhri, a village nearby to Pandharpur.

### Who are Varkaris?

- They are a Hindu religious sect that workship Vithoba (or Vitthal), an incarnation of Krishna.

## Gilgit Manuscripts

### Why in News

Recently, the Minister of State for Culture inaugurated an exhibition under the Azadi Ka Amrit Mahotsav (AKAM) titled “Hamari Bhasha, Hamari Virasat”.

### Important Points

- Minister of State for Culture inaugurated an exhibition under the Azadi Ka Amrit Mahotsav (AKAM) titled “Hamari Bhasha, Hamari Virasat” and mentioned about Gilgit Manuscripts to celebrate 75th International Archives Day at National Archives of India, New Delhi.

### Gilgit Manuscripts:

- It was written between the 5th -6th centuries CE, which is the oldest surviving manuscript collection in India.
- The birchbark and clay-coated Gilgit manuscripts are the oldest surviving manuscripts in India.
- These manuscripts include both canonical and non-canonical Buddhist works that throw light on the evolution of Sanskrit, Chinese, Korean, Japanese, Mongolian, Manchu and Tibetan religion-philosophical literature.
- They are used for the study of the history and development of Buddhist thought and writing is invaluable.
- These manuscripts can be dated back to the 5th to 6th Century A.D. and are written in the Buddhist hybrid Sanskrit language of the Gupta Brahmi and Post-Gupta Brahmi script of that period.
- The manuscripts were discovered in three instalments in the Gilgit region of Kashmir.



### Hamari Bhasha, Hamari Virasat Conclave

- The conclave is being organized to commemorate the treasured heritage of India’s linguistic diversity as a Nation.
- During the conclave, the National Archives of India has made available the Gilgit Manuscripts.
- India is blessed with extraordinary language diversity. According to an estimate out of 7,111 languages spoken globally, about 788 languages are spoken in India alone.

- India is thus one of the four most linguistically diversified countries in the world, along with Papua New Guinea, Indonesia, and Nigeria.

### What are Manuscripts?

- A manuscript is a handwritten composition on paper, bark, cloth, metal, palm leaf or any other material dating back at least seventy-five years that has significant scientific, historical or aesthetic value.
- These are found in hundreds of different languages and scripts. Often, one language is written in a number of different scripts.
- For example, Sanskrit is written in Oriya script, Grantha script, Devanagari script and many other scripts.
- These are distinct from historical records such as epigraphs on rocks, farmans, revenue records which provide direct information on events or processes in history. Manuscripts have knowledge content.

## Gulabi meenakari handicraft

### Why in News

The Uttar Pradesh state government has decided to gift GI-tagged Gulabi meenakari handicrafts to the visiting delegates from G20 nations.

### Important Points

#### A Unique Craft from Varanasi

- Gulabi Meenakari is a rare and exquisite craft practiced in the lanes of Varanasi, near Gai Ghat, in India.
- Varanasi is renowned for its exquisite Gulabi Meenakari handicraft, which showcases the skill and creativity of the artisans in the
- Originating from Persia, this art form involves the coloring of metal surfaces by fusing different colors.
- The art was brought to Varanasi during the Mughal era in the early 17th century by Persian enamellists.
- The word “mina” comes from the Persian word “Minoo,” meaning “heaven,” referring to the azure color of the sky.
- In Varanasi, Gulabi Meenakari is primarily practiced on jewelry and home decor items.
- The craft utilizes simple tools such as salai (etching tool), kiln, metal palette, mortar and pestle, kalam (enamel application tool), brass dye, small scrubbing brush, forceps, and takala (needle-like tool for applying colors).

#### Gulabi Meenakari is popularly found in three forms:

- Ek Rang Khula Meena: Only gold outlines are exposed, and a single transparent color is used.
- Panch Rangi Meena: Five colors – red, white, green, light blue, and dark blue – are employed.
- Gulabi Meena: Pink is the dominant color in this form.

#### Geographical Indications (GI) Tag

- Geographical Indications of Goods indicate the country or place of origin of a product.
- They assure consumers of the product’s quality and distinctiveness derived from its specific geographical locality.
- GI tags are an essential component of intellectual property rights (IPRs) and are protected under international agreements like the Paris Convention and TRIPS.



## Sedition Law

### Why in News

Law Commission Recommends Retention Of Sedition Law With Certain Amendments & Increased Punishment Upto Life Imprisonment

### Important Points

- The Law Commission of India has recommended the retention of the 153-year-old colonial law on sedition in India, emphasising that “repealing the legal provision can have serious adverse ramifications for the security and integrity of the country.”
- Instead, the Commission favoured amending Section 124A of the Indian Penal Code or IPC (sedition law) “so as to bring about more clarity in the interpretation, understanding, and usage of the provision.”
- According to the Commission, headed by former Karnataka high court chief justice Ritu Raj Awasthi, Section 124A should be amended to align it with the Supreme Court’s 1962 verdict in the Kedar Nath Case, which underlined that the presence of a pernicious tendency to incite violence is a precondition to invoke the sedition clause and that the penal provision cannot be used to stifle free speech.
- The 279th report of the Commission, answering a reference made to it by the Centre in March 2016, recommended that Section 124A should be amended to read as: “Whoever by words, either spoken or written, or by signs, or by visible representation, or otherwise, brings or attempts to bring into hatred or contempt, or excites or attempts to excite disaffection towards, the Government established by law in India, with a tendency to incite violence or cause public disorder shall be punished with imprisonment for life, to which fine may be added, or with imprisonment of either description for a term which may extend to seven years, to which fine may be added, or with fine.”

### Recommendation

- It added that the sedition law, which carries a maximum punishment of life imprisonment or “three years”, should be amended to enhance the alternative punishment to “seven years”, giving the courts greater room to award punishment for a case of sedition in accordance with the scale and gravity of the act.
- The operation of Section 124A, a non-bailable offence that activists and jurists have alleged is often misused to muzzle dissent, is on hold due to a continuing interim order of the Supreme Court.
- The proposed provision incorporates “with a tendency to incite violence or cause public disorder” in Section 124A, as elucidated in the Kedar Nath verdict, and enhances the alternative punishment from three to seven years in jail.
- The expression “tendency”, the Commission said, means a mere inclination to incite violence or cause public disorder rather than proof of actual violence or imminent threat to violence.
- It also prescribed procedural safeguards to minimise the abuse of the penal provision.
- Section 154 of the Criminal Procedure Code could be amended to hold that a first information report (FIR) under Section 124A would be registered only after a police officer, not below the rank of Inspector, conducts a preliminary inquiry and on the basis of the report made by the officer, the central government or the state government grants permission for registering the FIR.

### The Law Commission of India on sedition law:

- The sedition law is a reasonable restriction on the right to free speech.
- Repealing the legal provision can have serious adverse ramifications for the security and integrity of the country.
- Mere fact that a particular legal provision is colonial in its origin does not validate the case for its repeal.



- Jurisdictions like the US, UK, etc., have actually merged their sedition law with counter-terror legislations.
- Despite this, what some of these countries have actually done is that they have merged their sedition law with counter-terror legislations.
- Section 124A has its utility in combating anti-national and secessionist elements as it seeks to protect the elected government from attempts to overthrow it through violent and illegal means.
- The continued existence of the government established by law is an essential condition for the security and stability of the State.
- In this context, it becomes imperative to retain Section 124A and ensure that all such subversive activities are nipped in their incipiency.
- The absence of Section 124A, any expression that incites violence against the government would invariably be tried under the special laws and counter-terror legislation, which contain much more stringent provisions to deal with the accused.

## WHAT IS IT?

- **Sedition law:** Section 124A of the Indian Penal Code, 1860
- **Definition:** Whoever by words, either spoken or written, or by signs, or by visible representation, or otherwise brings or attempts to bring into hatred or contempt, or excites or attempts to excite disaffection towards, the government established by law in India, shall be punished
- **Punishment:** Imprisonment for life, to which fine may be added, or imprisonment which may extend to three years, to which fine may be added, or just a fine

## WHAT THE SUPREME COURT SAID: LANDMARK JUDGEMENTS

1962

### KEDAR NATH SINGH VS STATE OF BIHAR

The Supreme Court held that "a citizen has a right to say or write whatever he likes about the government, or its measures, by way of criticism or comment, so long as he does not incite people to violence"

1982

### P. ALAVI VS STATE OF KERALA

Where the court held that sloganeering, criticising of Parliament or the judicial set-up did not amount to sedition.

1995

### BALWANT SINGH AND ANR VS STATE OF PUNJAB

The SC says: "Raising some slogan ("Khalistan Zindabad") a couple of times...which neither evoked any response nor any reaction from the public cannot attract such punishment"

## Adverse possession

### Why in News

22nd Law Commission of India (LCI) in its 280th report has suggested that there is no need for changing the law relating to adverse possession.

### Important Points

- The Law Commission, headed by former Chief Justice of Karnataka High Court Ritu Raj Awasthi and comprising retired Kerala High Court judge KT Sankaran, said in its 280th report that there is no reason for increasing the period of limitation.
- However, two of its ex officio members filed a dissent note stating that the law does not stand judicial scrutiny and promotes false claims under the colour of adverse possession.

### Adverse possession

- The concept of adverse possession stems from the idea that land must not be left vacant but instead, be put to judicious use.
- Essentially, adverse possession refers to the hostile possession of property, which must be continuous, uninterrupted, and peaceful.
- According to the Law Commission's report, the rationale behind this comes from considerations that the "title to land should not long be in doubt", "society will benefit from someone making use of land the owner leaves idle," and "persons who come to regard the occupant as owner may be protected."
- The maxim that the law does not help those who sleep over their rights is invoked in support of adverse possession.
- Simply put, the original title holder who neglected to enforce his rights over the land cannot be permitted to re-enter the land after a long passage of time.



## Background

- While the concept originally dates back to 2000 BC, finding its roots in the Hammurabi Code, the historical basis of “title by adverse possession” is the development of the statutes of limitation on actions for recovery of land in England.
- The first such statute was the Statute of Westminster, 1275.
- However, it was the Property Limitation Act, 1874, that set the period of limitation at twelve years from when the cause of action first arose, which laid the groundwork for the limitations model inherited by colonial India.
- The first attempt to bring the law of limitation to domestic shores was the “Act XIV of 1859”, which regulated the limitation of civil suits in British India.
- After the passage of the Limitation Act in 1963, the law on adverse possession underwent significant changes.

## What provisions did the Limitation Act, 1963 bring with it?

- The 1963 Act fortified the position of the true owner of the land, as he now had to merely prove his title, while the burden of proof of adverse possession shifted to the person claiming it.
- Under the Limitation Act, 1963, any person in possession of private land for over 12 years or government land for over 30 years can become the owner of that property, as laid down in Articles 64, 65, 111, or 112 of the 1963 Act, relating to suits for possession of immovable property.
- According to Article 65 of Schedule I of the 1963 Act, a person in adverse possession of immovable property acquires title to that property.
- However, the possession must be open, continuous, and “in defiance of the title of the real owner for twelve years.” Similarly, Article 64 governs suits for possession based on previous possession and not on title.
- Meanwhile, Article 112, which applies to government property, mandates a requirement of 30 years for granting a title by adverse position.
- Further, Article 111 says that the limitation period for the State will be 30 years from the date of dispossession for land belonging to a private person where any public street or road or any part of it has been dispossessed and no suit has been moved for its possession “by or on behalf of any local authority”.

## What are the main ingredients of adverse possession?

- In the 2004 Apex Court ruling in *Karnataka Board of Wakf v Government of India*, the court dealt with the ingredients of adverse possession.
- According to the observations made by former SC judge S. Rajendra Babu in the case, “A person who claims adverse possession should show:
  - (a) on what date he came into possession,
  - (b) what was the nature of his possession,
  - (c) whether the factum of possession was known to the other party,
  - (d) how long his possession has continued, and
  - (e) his possession was open and undisturbed.”
- For the adverse possession to be “open,” or without any attempt at concealment, it doesn’t need to be brought to the specific knowledge of the owner.
- However, such a requirement may be insisted on where an ouster of title is pleaded.
- Further, the mandate for such possession to be “undisturbed” requires a “consistent course of conduct, which means that it cannot be shown by a “stray or sporadic act of possession.”
- In the 1981 ruling in *Kshitish Chandra Bose vs. Commissioner of Ranchi*, the top court delineated the requirements of openness and continuity.
- However, in a series of decisions, the SC recommended that the government seriously consider the issue of “adverse possession” and make suitable changes.

## SC suggest changes to the law on adverse possession

- A two-judge SC bench, in its 2008 ruling in *Hemaji Waghaji Jat v. Bhikhabhai Khengarbhai Harijan and Others*, while dealing with Article 65 of the Schedule of the Limitation Act, 1963, observed that the law of adverse possession “ousts an owner on the basis of inaction within limitation” and is “irrational, illogical, and wholly disproportionate”.

- The law as it exists is extremely harsh for the true owner and a windfall for a dishonest person who has illegally taken possession of the property, the court said.
- Adding that the law should not benefit the illegal action of a “rank trespasser” who had wrongfully taken possession of the true owner’s property, the court said that it also “places a premium on dishonesty”.
- Emphasising the “urgent need” for “a fresh look regarding the law on adverse possession”, the court recommended the government “to seriously consider and make suitable changes in the law of adverse possession”.

## UGC guidelines

### Why in News

MoE announces new UGC guidelines for granting deemed university status

### Important Points

- Higher education institutions which are less than 20 years old will now be eligible to apply for deemed university status and private universities will have to create executive councils like central universities, according to the University Grants Commission’s revised guidelines.
- The Centre has released the revised guidelines for existing higher education institutions to get the deemed to be status by simplifying the eligibility criteria in order to establish more quality-focused deemed universities.
- Union Education Ministry released the UGC (Institutions Deemed to be Universities) Regulations, 2023, which will replace the 2019 guidelines.
- The new rules are built on the principle of a “light but tight” regulatory framework envisioned in the National Education Policy 2020.
- The new simplified guidelines will encourage universities to focus on quality and excellence, strengthen the research ecosystem and have a long-term impact in transforming our higher education landscape.
- The norms will facilitate creation of many more quality-focused deemed to be universities in an objective and transparent manner.
- The University Grants Commission (UGC) Act provides for the central government to declare any institution other than a university the status of institution deemed to be university.
- The first set of regulations in this regard was notified in 2010 and these were subsequently revised in 2016 and 2019.

### 2019 Guidelines and New Regulations

- Under the 2019 guidelines, the higher education institutions having “existence for not less than 20 years” were eligible for applying for the status.
- However, the revised guidelines have now replaced it with multi-disciplinarity, NAAC grading, NIRF ranking and NBA grading.
- It means any multi-disciplinary institution having valid accreditation by NAAC with at least 3.01 cumulative grade point average (CGPA) for three consecutive cycles, NBA accreditation for two-thirds of eligible programmes for three consecutive cycles or in the top 50 of any specific category of NIRF for the last three years continuously will be able to apply for the deemed status, the guidelines stated.
- Besides, a cluster of institutions managed by more than one sponsoring body or a society can also apply for deemed to be university status.
- The new regulations also introduces the “Distinct Institution” category, where an existing institution or an institution starting from the beginning with the focus on teaching and research in unique disciplines and/or addressing the strategic needs of the country or engaged in the preservation of Indian cultural heritage or preservation of the environment or dedicated to skill development or dedicated to sports or languages or any other discipline, so determined by the Expert Committee of Commission, will be exempted from eligibility criteria.
- There are around 170 deemed institutions in the country currently.
- Among other criteria that have been changed are the faculty strength has been increased from 100 to 150, corpus fund for private institutions has been increased from Rs 10 crore to Rs 25 crore, and creation of an executive councils like central universities in these universities as well.



- The revised guidelines have also made it mandatory for deemed universities to register on Academic Bank of Credits (ABC).
- Besides, deemed universities with minimum 'A' grade and above or ranked from 1 to 100 in the "universities" category of NIRF rankings of the relevant year are eligible to set up off-campus centres.
- Institutions declared as deemed to be university under a 'distinct category' can apply for off-campus after five years of their declaration if they are accredited with an A grade or figured in the top 100 in the 'universities' category of NIRF.

#### In short:

- Regulations are aligned with National Education Policy, 2020.
- Eligibility criteria to apply for deemed-to-be university status to be:
  - NAAC 'A' grade with at least a 3.01 CGPA for three consecutive cycles.
  - NBA accreditation for two third of eligible programmes for three consecutive cycles.
  - In top 50 of any specific category of NIRF (National Institutional Ranking Framework) for last three years continuously.
  - In top 100 of overall NIRF Ranking for last three years continuously.

## Uniform Civil Code

### Why in News

Law Commission of India solicits views & ideas of the public and recognized religious organizations about Uniform Civil Code

### Important Points

- The 22nd Law Commission will conduct a comprehensive reevaluation of the UCC in light of its importance and the multitude of court rulings, ensuring a thorough examination of the subject.
- Initially the 21st Law Commission of India had examined the subject on Uniform Civil Code and solicited the views of all the stakeholders through its appeal along with a questionnaire.
- The 21st Law Commission has issued the consultation paper on "Reforms of Family Law".
- Since more than three years have been lapsed from the date of issuance of the said Consultation Paper, bearing in mind the relevance and importance of the subject and also the various Court orders on the subject, the 22nd Law Commission of India considered it expedient to deliberate afresh over the subject.
- Accordingly, the 22nd Law Commission of India decided again to solicit views and ideas of the public at large and recognized religious organizations about the Uniform Civil Code.
- Previously, in 2016, the Ministry of Law and Justice, made a reference to the Law Commission to examine all matters relating to the implementation of a UCC.
- The UCC calls for formulation of one law to be made applicable to all religious communities in matters such as marriage, divorce, inheritance, and adoption.
- It is intended to replace the system of fragmented personal laws, which currently governs interpersonal relationships and related matters within different religious communities.

### About Uniform Civil Code

- The Uniform Civil Code (UCC) calls for the formulation of one law for India, which would be applicable to all religious communities in matters such as marriage, divorce, inheritance, adoption.

### History

- It dates back to colonial India when the British government submitted its report in 1835 stressing the need for uniformity in the codification of Indian law relating to crimes, evidence, and contracts, specifically recommending that personal laws of Hindus and Muslims be kept outside such codification.





- An increase in legislation dealing with personal issues at the far end of British rule forced the government to form the B N Rau Committee to codify Hindu law in 1941.
- The task of the Hindu Law Committee was to examine the question of the necessity of common Hindu laws. The committee, in accordance with scriptures, recommended a codified Hindu law, which would give equal rights to women. The 1937 Act was reviewed and the committee recommended a civil code of marriage and succession for Hindus.

#### **Constitutional Provisions:**

- The Uniform Civil Code (UCC) was included in the Directive Principles.
- Article 44: The “State shall endeavour to provide for its citizens a uniform civil code (UCC) throughout the territory of India.”

#### **Need of UCC**

- Uniform Principles: Common Code would enable uniform principles to be applied in respect of aspects such as marriage, divorce, succession etc.
- Promotion of secularism: One set of laws to govern the personal matters of all citizens irrespective of religion is the cornerstone of true secularism.
- Protection of Vulnerable & Women’s Rights: It will protect the vulnerable sections of society.
- Reduced Discord: if and when the whole population will start following the same laws, chances are there that it would bring more peace in the living and reduce riots.
- Prevents religion-based discrimination: Personal laws differentiate between people on grounds of religion. A unified law having the same provisions regarding marital affairs would provide justice to those who feel discriminated against.
- Remove vote bank politics: Opting the UCC will remove the religious nexus of the Political system in which voters are divided on the basis of religion, caste etc.
- Eases Administration: UCC would make it easy to administer the huge population base of India.
- Global practice of UCC: Almost all Muslim nations like Morocco, Pakistan etc. have been following the UCC.
- National integration: A common civil code will help the cause of national integration by removing disparate loyalties to laws that have conflicting ideologies.
  - Goa is the only state in India that has a uniform civil code regardless of religion, gender, caste.
  - Goa has a common family law.

## **Inclusion of 80 Castes in OBC List by NCBC**

### **Why in News**

National Commission for Backward Classes (NCBC) is processing the request for the approval of about 80 more castes in six States, (Maharashtra, Telangana, Andhra Pradesh, Himachal Pradesh, Punjab, and Haryana) for the inclusion in the OBC list.

### **Important Points**

#### **Other Backward Class (OBC):**

- OBC refers to socially and educationally backward classes of citizens.
- The Supreme Court has ruled that the creamy layer, i.e., socially and economically advanced individuals within the OBC category, should be excluded from reservations.

#### **Role of National Commission for Backward Classes (NCBC):**

- NCBC is a statutory body responsible for reviewing requests for caste inclusion in the Central OBC list.
- The commission forms a Bench to examine proposals and forwards its decisions to the Union government.
- Once approved by the cabinet, legislation is enacted, and the President notifies the changes.

#### **Constitutional Provisions:**

- Article 15(4) empowers the state to make special provisions for the advancement of socially and educationally backward classes, including OBCs.
- These provisions include reservation of seats in educational institutions, financial assistance, scholarships, and housing.
- Article 16(4) allows the state to enact laws for the reservation of appointments or posts in favor of OBCs.

### Achievements of the Union Government:

- Since 2014, the government has added 16 communities to the Central OBC list in Himachal Pradesh, Bihar, Jharkhand, Madhya Pradesh, and Jammu and Kashmir.
- The 105th Amendment to the Constitution affirms states' rights to maintain their own OBC lists, preserving the benefits for 671 State OBC communities.

### About National Commission for Backward Classes

- 102nd Constitution Amendment Act, 2018 provides constitutional status to the National Commission for Backward Classes (NCBC).
- It has the power to look into welfare claims and programmes for socially and academically disadvantaged groups.
- Prior to this, the Ministry of Social Justice and Empowerment was responsible for the NCBC as a statutory organisation.

### Background of NCBC

- Two Backward Class Commissions were appointed in 1950s and 1970s under Kaka Kalelkar and B.P. Mandal respectively.
- Kaka Kalelkar commission is also known as the First Backward Classes Commission.
- The Supreme Court ordered the government to establish a permanent committee to consider, investigate, and recommend the inclusion and exclusion of various Backward Classes for the purpose of benefits and protection in the Indra Sawhney case of 1992.
- The National Commission for Backward Classes Act, passed by parliament in 1993 in accordance with these directives, established the NCBC.
- The 123rd Constitution Amendment bill of 2017 was presented in Parliament in order to better protect the interests of underprivileged groups.
- The National Commission for Backward Classes Act, 1993, was repealed by a different law that was approved by Parliament, making the 1993 Act obsolete.
- The bill got the President assent in August 2018 and provided the constitutional status to NCBC.

### Composition:

- The Commission consists of:
  - Chairperson
  - Vice-Chairperson
  - Three other Members in the rank and pay of Secretary to the Govt of India.
- Their condition of service and tenure of office has been notified by the Ministry of Social Justice and Empowerment.
- NCBC is headquartered in Delhi.

### Constitutional Provisions

- Article 340 deals with the need to, inter alia, identify those “socially and educationally backward classes”, understand the conditions of their backwardness, and make recommendations to remove the difficulties they face.
- 102nd Constitution Amendment Act inserted new Articles 338 B and 342 A.
- The amendment also brings about changes in Article 366.
- will be required if the list of backward classes is to be amended.

## Right to Change One's Name and The Right To Life

### Why in News

The right to change one's name or surname is a part of the right to life under Article 21, the High Courts (HC) of Allahabad and Delhi said.

### Important Points

- The Allahabad HC said that the fundamental right to keep/change one's name is vested in every citizen under Articles 19(1)(a), 21, and 14 of the Constitution, while the Delhi HC ruled that the right to identity is an “intrinsic part” of Article 21.

### Cases before the HCs

- In 'Sadanand & Anr. vs CBSE & Ors', a plea was filed by two brothers before the Delhi HC.
  - Owing to caste atrocities suffered, the father had earlier changed his surname and published it in the newspaper and the Gazette of India as required.
  - His surname was changed across various public documents, such as Aadhaar, PAN, and Voter ID.
  - However, CBSE refused to update the brothers' certificates with the father's new surname as this would subsequently entail a change in their caste, which could be misused.
- In 'Md. Sameer Rao vs. State of UP', the Allahabad HC dealt with a petition filed against an order rejecting petitioner's application to change his name in his High School and Intermediate certificates, seemingly for a higher sense of self-worth.
- The state argued that a change in the name is not an absolute right and is subject to restrictions imposed by law.

### The Ruling of the HCs:

#### The Allahabad HC:

- The authorities had arbitrarily rejected the application for a change of name, and such actions violated the fundamental rights of the petitioner guaranteed under Article 19(1)(a), Article 21, and Article 14 of the Constitution.
- A name is an indispensable component of a person's identity and falls within the realm of the right to privacy.
- Congruence in all identity-related documents is essential. Allowing one to carry identification documents with separate names would lead to confusion/ mischief.

#### The Delhi HC:

- The father had decided to change his surname in order to overcome the social stigma and the disadvantage faced by his sons and that CBSE's denial was totally unjustified.
- The petitioners have every right to have an identity which gives them an honourable and respectable identity in the society.
- If they suffered any disadvantage on account of their surname or faced social prejudices due to it, they are certainly entitled to a change of their identity.

### What did the HCs say about Article 21?

- In both the Delhi and Allahabad HC cases, a common thread of Article 21 was found running.
- The Allahabad HC observed that the right to keep a name of choice/ change the name according to personal preference comes within the mighty sweep of the right to life and personal liberty guaranteed under Article 21.
- The court relied on the Kerala HC ruling (2020), which ruled that to have a name and to express the same is certainly a part of the right to freedom of speech and expression under Article 19 (1)(a) and Article 21.
- The Delhi HC held that the "Right to Identity" is an intrinsic part of the Right to Life under Article 21.
- There is no denying the fact that the Right to Life includes within its ambit, the Right to Live with Dignity, which includes not to be tied down by any casteism faced by a person due to the caste to which s/he belongs.

### Restrictions on the right to change names :

- Reasonable Restrictions: The Allahabad High Court clarified that the right to change or keep one's name is not an absolute right and is subject to reasonable restrictions.
- Article 19(2): The state or its instrumentalities cannot hinder the use of any name or change of name, except as prescribed under Article 19(2) of the Constitution. Article 19(2) allows for restrictions in the interests of security and sovereignty of India, friendly relations with foreign states, public order, decency, or morality.
- Fair, Just, and Reasonable: Any restrictions imposed by law on fundamental rights, including the right to change names, must be fair, just, and reasonable. This principle was established in the case of K. S. Puttaswamy vs. Union of India (2017).
- Proportionality: The principle of proportionality is crucial in determining the validity of restrictions on rights. It ensures that the encroachment on the right is not disproportionate to the purpose of the law.

## GRAI

### Why in News

Grievance Redressal Assessment and Index (GRAI) 2022 launched

### Important Points

The Grievance Redressal Assessment and Index (GRAI) 2022 is an initiative by the Department of Administrative Reforms and Public Grievances (DARPG), Government of India.

#### About the GRAI 2022:

- The GRAI was conceptualized and designed by the Department of Administrative Reforms and Public Grievances (DARPG) with the objective of presenting a comparative picture of grievance redressal mechanisms in different organizations.
- A total of 89 Central Ministries and Departments were assessed and ranked based on a comprehensive index.
- The assessment focused on four dimensions: Efficiency, Feedback, Domain, and Organizational Commitment. These dimensions were evaluated using 12 corresponding indicators.
- GRAI has highlighted that time taken in disposing of grievances declined from 32 days in 2021 to 18 days in 2023.
- The data used for computing the index was collected from the Centralised Public Grievance Redressal and Management System (CPGRAMS) for the period between January and December 2022.

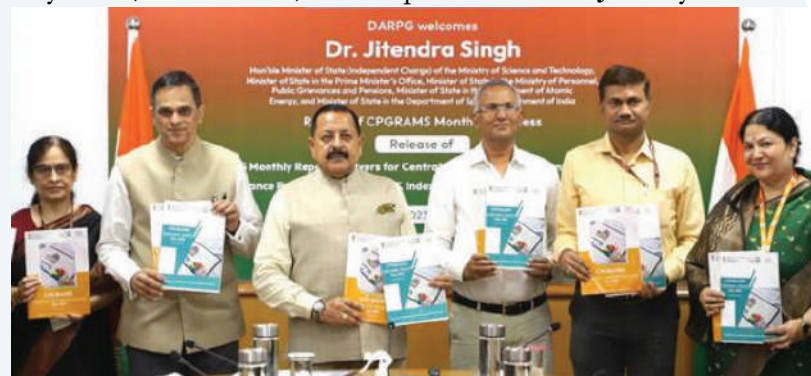

#### About CPGRAMS

- CPGRAMS is an online platform that aims to enable submission of grievances by the aggrieved citizens from anywhere and anytime
- (24x7).
- Tracking grievances is facilitated through the system generated unique registration number.
- Available in 22 scheduled languages along with English.
- In 2022, the Government implemented the 10-step reforms of CPGRAMS.
- It included Universalization of CPGRAMS 7.0, Technological Enhancements using AI/ML, etc.
- CPGRAMS is also accessible to citizens through a standalone mobile application, making it convenient for individuals to submit their grievances and track the progress of their complaints.

#### CPGRAMS Reforms 7.0: Benefits

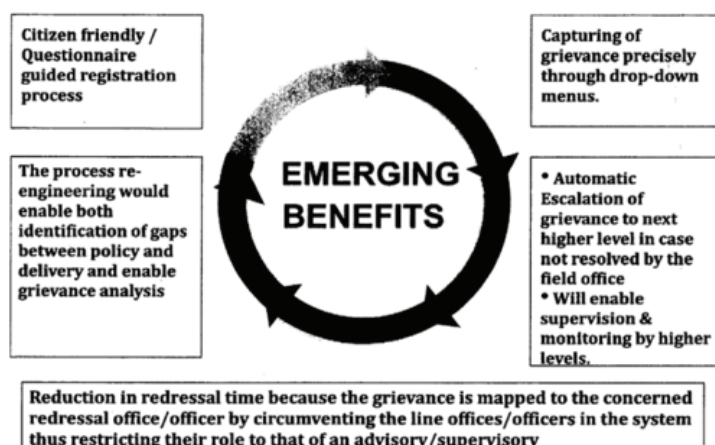



## Earth System Boundaries (ESBs)

### Why in News

Earth's health failing in seven out of eight key measures, say scientists

### Important Points

- Human activity has pushed the world into the danger zone in seven out of eight newly demarcated indicators of planetary safety and justice, according to a groundbreaking analysis of the Earth's wellbeing.
- Going beyond climate disruption, the report by the Earth Commission group of scientists presents disturbing evidence that our planet faces growing crises of water availability, nutrient loading, ecosystem maintenance and aerosol pollution. These pose threats to the stability of life-support systems and worsen social equality.
- The study, which was published in Nature is the most ambitious attempt yet to combine vital signs of planetary health with indicators of human welfare.
- Study is an attempt to do an interdisciplinary science assessment of the entire people-planet system.

### Earth Commission

- The Earth Commission, which was established by dozens of the world's leading research institutions, wants the analysis to form the scientific backbone of the next generation of sustainability targets and practices, which extend beyond the current focus on climate to include other indices and environmental justice.
- It hopes that cities and businesses will adopt the targets as a way to measure the impact of their activities.
- The study sets out a series of "safe and just" benchmarks for the planet that can be compared to the vital signs for the human body.
- Instead of pulse, temperature and blood pressure, it looks at indicators such as water flow, phosphorus use and land conversion.
- The boundaries are based on a synthesis of previous studies by universities and UN science groups, such as the Intergovernmental Panel on Climate Change and the Intergovernmental Science-Policy Platform on Biodiversity and Ecosystem Services.
- The situation is grave in almost every category. Setting global benchmarks is challenging.
- For climate, the world has already adopted a target to keep global heating as low as possible between 1.5C to 2C above pre-industrial levels.
- The Earth Commission notes that this is a dangerous level because many people are already badly affected by the extreme heat, droughts and floods that come with the current level of about 1.2C.
- They say a safe and just climate target is 1C, which would require a massive effort to draw carbon dioxide from the atmosphere. They note it is impossible to stabilise the climate without protecting ecosystems.

### Safe and Just

- To achieve the climate target, the "safe and just" boundary is for 50 to 60% of the world to be home to predominantly natural ecosystems.
- The reality, however, is that only 45 to 50% of the planet has an intact ecosystem.
- In human-altered areas, such as farms, cities and industrial parks, the commission says at least 20 to 25% of the land needs to be devoted to semi-natural habitats such as parks, allotments and clusters of trees in order to maintain ecosystem services such as pollination, water quality regulation, pest and disease control, and the health and mental health benefits provided by access to nature.
- However, about two-thirds of altered landscapes fail to meet this goal.
- Another target is for aerosol pollution, which accumulates from car exhausts, factories, and coal, oil and gas power plants. At a global level, the report has focussed on minimising the imbalance of aerosol concentrations between the northern and southern hemispheres, which can disrupt the monsoon season and other weather patterns.

- At a local level, for example in cities, it follows the World Health Organization in establishing a boundary of 15 micrograms per cubic metre mean annual exposure to small particulate matter, known as PM2.5, which can damage the lungs and heart.
- This is an issue of social justice because poorer, often predominantly black communities tend to suffer the worst results as many are found in vulnerable areas.

### Safe boundary

- The benchmark for surface water is that no more than 20% of the flow of rivers and streams should be blocked in any catchment area because this leads to declining water quality and habit loss for freshwater species.
- This “safe boundary” has already been exceeded on a third of the world’s land by hydroelectric dams, drainage systems and construction.
- The story is similarly poor for groundwater systems, where the safe boundary is that aquifers are not depleted faster than they can be replenished.
- However, 47% of the world’s river basins are being run down at an alarming rate.
- This is a big problem in population centres such as Mexico City and areas of intensive agricultural such as the North China Plain.
- Nutrients are another area of concern because farmers in wealthier countries are spraying more nitrogen and phosphorus than the plants and land are able to absorb.
- This temporarily increases yields, but leads to runoffs into water systems that become suffocated by algae blooms and unhealthy for humans to drink.
- Global equity is the key here, the report says. Poorer nations need more fertilisers, while rich nations need to cut the surplus.
- Balanced out, the “safe and just boundary” in this case is a global surplus of 61m tonnes of nitrogen and about 6m tonnes of phosphorus.

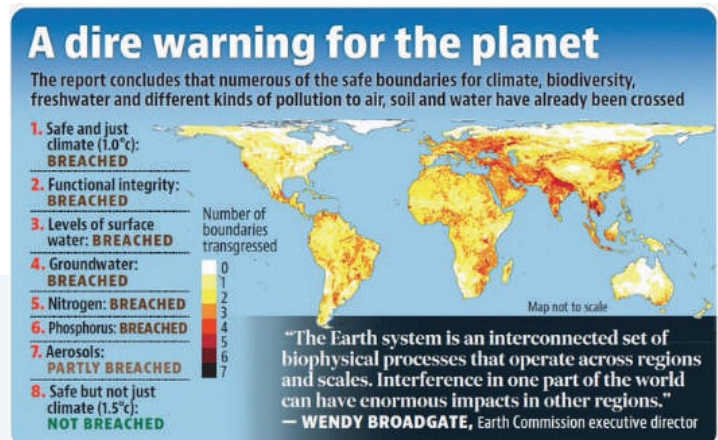

## National Working Plan Code-2023

### Why in News

National Working Plan Code-2023 released for scientific management of forests and evolving new approaches

### Important Points

- The Ministry of Environment, Forest & Climate change has released the “National Working Plan Code-2023” for scientific management of forests and evolving new approaches.
- The National Working Plan Code-2023 was released by Ministry of Environment, Forest & Climate change during the occasion of the ‘World Day to Combat Desertification and Drought’ organized by the Indian Council of Forestry Research and Education (ICFRE) in Dehradun.
- India is one of the few countries in the world that has a scientific system of forest management.
- The working plan is the main instrument through which the scientific management of Forests is being achieved in India. National Working Plan Code which was first adopted in 2004 with a subsequent amendment in 2014 brought uniformity and acted as the guiding principle for the preparation of the working plan for scientific management of different forest divisions of our country.



- The forests in India are being managed for a multitude of reasons like maintaining environmental stability, conserving natural heritage, checking soil erosion and denudation of catchment areas, checking the extension of dunes, increasing tree and forest cover with people involvement, increasing the productivity of forests etc.
- Scientific forest management in India and the world is consistently evolving with new approaches, new technologies & innovations and it has become imperative to evolve ourselves to meet the essentials of forest management and the requirements of people who depended on it.

### **National Working Plan Code-2023**

- The National Working Plan Code-2023 will act as a guiding principle for State Forest Departments in preparation for the working plan for different forest divisions in the country.
- National Working Plan Code-2023 deals in detail with the essentials of forest management planning, incorporating the principles of sustainable management of forests.
- This includes extent and condition of forest and tree cover; maintenance, conservation and enhancement of biodiversity including wildlife, forest health and vitality, conservation and management of soil and water resources, enhancement of forest resource productivity, maintenance and enhancement of social, economic, cultural and spiritual benefits, and providing the appropriate policy, legal and institutional framework.
- For the first time, the National Working Plan Code-2023 has prescribed state forest departments to engage in continuous data collection and its updation in a centralized database.
- The “Indian Forest Management Standard” which is a part of this code, takes into account the diverse forest ecosystem in our country, while trying to bring in uniformity in management.
- The Standards for Sustainable Forest Management have been codified in the Indian Forest Management Standard, based on long term experiences of scientific forest management in India and in sync with international criteria and indicators. Indian Forest Management Standard would facilitate the State Forest Departments to measure effectiveness of the management practices against prescriptions of Working Plans.

## **G20 agriculture ministers’ meeting**

### **Why in News**

Recently, the three-day G20 Agriculture Ministers Meeting got concluded in Hyderabad.

### **Important Points**

- The three-day G20 Agriculture Ministers Meeting that concluded in Hyderabad adopted an ‘Outcome Document and Chair’s Summary’ which reiterated its commitment to food security and nutrition for all while also calling for action on food security and nutrition.
- Describing the consensus in adopting the document as “historical”, an official release said it was reached after deliberations on various issues centred around the agriculture sector wherein leadership of G20 developing countries was envisaged.
- India’s initiatives for G20’s concrete deliverables – the Deccan High Level Principles on Food Security and Nutrition 2023 and 12th G20 MACS international initiative for research on millets and other ancient grains aimed to enhance global food security and nutrition.

### **Deccan High Level Principles:**

- Demonstrated G20 collective responsibility in response to global food security crises.
- Facilitating humanitarian assistance to countries and populations in vulnerable situations.
- Strengthen food safety nets and access to nutritious food.
- Focus on climate smart and climate resilient agricultural supply chains.

### **International Millets and Other Ancient Grains Research Initiative (MAHARISHI):**

- Aims at advancing research collaborations and generating awareness about millets and other ancient grains during
- International Years of Millets 2023 and after

### **Priority areas were highlighted**

- Promotion of agricultural diversity and improvement of social security systems to enhance food security and nutrition.



- Financing climate-friendly technologies for sustainable agricultural production.
  - Inclusive growth through a resilient agriculture supply chain.
  - Digitization of agricultural sector and standardization of agricultural data platforms.
- While acknowledging the long-term increase in global food production to meet the needs of a growing population, the G20 Ministers of Agriculture, in the document, said they are gravely concerned by the worsening global food insecurity situation and intensifying malnutrition rates, in several developing and least developed countries.
  - In the document, the G20 Ministers of Agriculture reiterated the urgency noted in the G20 Matera and Bali Leaders' Declarations emphasising the need to work together to promote food security and nutrition.
  - The global food insecurity situation and malnutrition rates are compounded by poverty, the Covid-19 pandemic, deepening climate change and biodiversity loss crises, and ongoing conflicts in the world.
  - In their 'Call for Action' on 'Food Security and Nutrition', the ministers noted with concern the high prices, ongoing disruptions in global supply chains, and excessive price volatility of food and fertilisers.
  - While stressing the importance of diverse, safe, and sustainably produced nutritious food to improve food security and nutrition, the ministers stated in the document that they encourage initiatives to promote innovations in crop development, production and consumption patterns.
  - To promote food security and nutrition programmes, the ministers agreed to share best practices and experiences with each other.
  - The ministers resolved to collaborate in areas such as climate-resilient technologies, nature-based solutions and ecosystem-based approaches and foster better dissemination of existing traditional and local knowledge for sustainable agriculture.
  - They called for an integrated and multi-sectoral 'One Health' approach to simultaneously balance and optimise the health of people, animals, plants and ecosystems, and combat anti-microbial resistance (AMR) to reduce the risks from emerging and currently occurring zoonotic diseases with pandemic potential and other threats to global public health security.
  - The ministers expressed deep gratitude to India's Presidency of G20, and for its leadership in stewarding the agricultural agenda in 2023 and said they look forward to Brazil's Presidency of G20 in 2024, and South Africa's Presidency in 2025.



## FAO

### Why in News

Declining food imports by most vulnerable countries a cause for concern.

### Important Points

- Food imports by vulnerable countries are expected to decline in 2023, raising concerns, according to a report by the United Nations' Food and Agriculture Organization (FAO).
- However, imports by advanced economies continue to expand and the global bill may reach a new record this year.
- The food import bill for the least developed countries was predicted to decline by 1.5 per cent this year.
- Net food-importing developing countries may see a 4.9 per cent decline, the FAO said in its biannual report on global food markets released recently.
- The decline in food import volumes in both groups is a concerning development, suggesting a decline in purchasing capacity.
- Lower international prices for a number of primary food items have not fully translated into lower costs at domestic retail levels, it also suggested, pointing out that cost-of-living pressures could persist in 2023.

- Even then, the world food import bill was forecast to reach a record high, said FAO. It estimated that the global food bill will rise to \$1.98 trillion in 2023, up by 1.5 per cent from 2022.
- However, it is predicted to grow at a much slower pace compared to last year as prices rising globally dampen demand. The world food import bill rose by 11 per cent in 2022 and 18 per cent in 2021.
- The quotations for fruits, vegetables, sugar and dairy products are much higher, throwing cold water on demand, especially in the most economically vulnerable countries.
- Meanwhile, world rice production is forecast to rise by 1.3 per cent in 2023-24 to 523.5 million tonnes, while international trade is expected to drop by 4.3 per cent in volume terms to 53.6 million tonnes.
- In contrast, wheat production in 2023 is expected to decline by 3 per cent from its all-time high of 777 million tonnes in 2022, mainly due to expected decreases in the Russian Federation and Australia as they registered record production last year.



### About Food and Agriculture Organization (FAO)

- Founded in 1945, a specialized agency of the United Nations that leads international efforts to defeat hunger.
- Members: 194 countries (including India) and European Union.
- Goals
- Eradication of hunger, food insecurity and malnutrition;
- Elimination of poverty and driving forward of economic and social progress for all; and
- Sustainable management and utilization of natural resources, including land, water, air, climate and genetic resources.
- HQ: Rome, Italy

## Sundargarh Forest

### Why in News

The Geological Survey of India (GSI) state unit has proposed declaring the “Natural Arch” in the Kanika range of Sundargarh forest division in Odisha as a Geo Heritage Site.

### Important Points

- The natural arch, believed to date back to the Jurassic period, would be the largest natural arch in India with the Geo Heritage tag.
- The site showcases primary sedimentary structures and is believed to have formed due to fault activities and sub-aerial weathering.
- The GSI had previously declared Pillo Lava at Nomira in Keonjhar district as a Geo Heritage Site.
- Geo-heritage refers to the geological features which are inherently or culturally significant offering insight into earth’s evolution or history to earth science or that can be utilized for education.



### Geological Survey of India:

- Headquartered in Kolkata, it was set up in 1851 primarily to find coal deposits for the Railways.
- Presently, GSI is an attached office to the Ministry of Mines.
- The main functions of the GSI relate to the creation and updation of national geoscientific information and mineral resource assessment.

## World's first treaty to protect the high seas

### Why in News

UN adopts world's first international treaty to protect the high seas

### Important Points

- The UN has adopted the world's first treaty to protect the high seas and preserve marine biodiversity in international waters, marking a milestone after nearly 20 years of effort, UN announced recently.
- The adoption followed an agreement reached by more than 100 countries on the text of the High Seas Treaty, also known as the Biodiversity Beyond National Jurisdiction treaty, after more than 15 years of discussions and five rounds of UN-led negotiations.
- In approving the text, member states have pumped new life and hope to give the ocean a fighting chance.
- The agreement will be open for signature in New York for two years.
- It will take effect after 60 countries ratify the agreement, according to the UN.
- It has been adopted under the framework of United Nations Convention on Laws of the Sea (UNCLOS).
- The pact is a key plank in efforts to put 30 percent of the world's land and sea under environmental protection by 2030.
- Among other provisions, the legally binding agreement would govern sharing benefits derived from marine genetic resources beyond national jurisdictions, creating protected areas on the high seas and establishing a framework for assessing environmental damage.

### Key highlights of the treaty

- Strengthening resilience and contains provisions based on polluter-pays principle as well as mechanisms for disputes.
- Parties must assess potential environmental impacts of any planned activities beyond their jurisdictions.
- Offers guidance, including through an integrated approach to ocean management that builds ecosystem resilience to tackle adverse effects of climate change and ocean acidification.
- Recognize rights and traditional knowledge of indigenous peoples and local communities, freedom of scientific research, and need for the fair and equitable sharing of benefits.
- It aims to establish large-scale marine protected areas in international waters, which protect marine biodiversity in high seas.
- It also calls for setting up of a Conference of Parties to oversee and enforce compliance with treaty's terms.

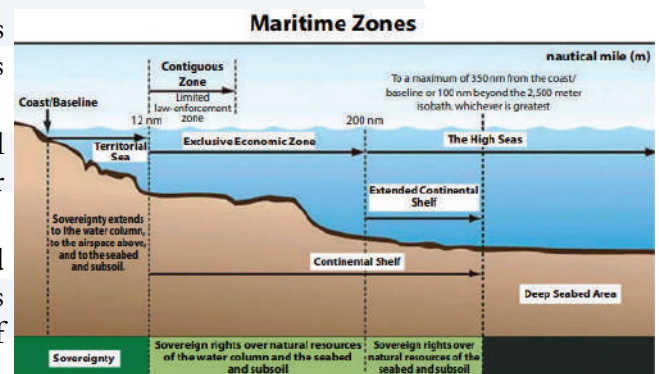

## Earthquakes

### Why in News

Recently Six earthquakes hit Jammu and Kashmir & Ladakh within 24 hours

### Important Points

- Within a 24-hour period, Jammu and Kashmir and Ladakh witnessed a series of six weak earthquakes, with the strongest one measuring 4.5 on the Richter scale.
- An earthquake measuring 3.0 on the Richter scale near Jammu and Kashmir was also felt after the first tremors.
- The National Centre for Seismology (NCS) too has verified that numerous weak earthquakes were felt in the Jammu & Kashmir and Ladakh regions.
- According to a meteorological department official, the hilly Ramban district along the Jammu-Srinagar national highway served as the epicentre of the 3.0 magnitude tremor.





- The earthquake occurred at a depth of 5 kilometres, at latitudes of 33.31 degrees north and 75.19 degrees east.

### What is an Earthquake?

- An earthquake refers to the shaking of the earth's surface caused by a sudden release of energy within the earth's crust. This release of energy generates seismic waves, commonly known as S waves. The intensity and characteristics of an earthquake are determined by the seismic activities occurring in a specific region.

### Causes an Earthquake

- Earthquakes occur due to sudden tectonic movements within the Earth's crust.
- The Earth's crust is divided into large sections called tectonic plates, which float on the semi-fluid layer known as the asthenosphere.
- These plates are constantly in motion, albeit very slowly.
- Divergent and convergent borders, as well as transform boundaries, can arise when two tectonic plates contact. When two plates meet or slide past one another near convergent boundaries, the strongest and most catastrophic earthquakes often result.
- Subduction is the process of forcing one tectonic plate beneath another along a convergent boundary. Huge pressure and friction are created as the plates slam into or pass one another.
- Rocks near the plate borders eventually crack and slip as a result of too much tension.
- An earthquake is caused by the rapid release of stored energy, which causes seismic waves.

### Seismograph

- A seismograph is an instrument that measures and records the details of an earthquake such as its duration, force, and direction.
- The seismograph has a pen attached to it.
- When an earthquake occurs, the pen also vibrates along with the vibrations produced by the earthquake.
- The pen records the movements of vibrations on a moving strip of paper.
- Various waves which are formed by the moving pen give us an estimate of the direction and force of an earthquake. It also calculates the difference in the arrival of P and S waves.

### Richter scale

- The intensity of an earthquake is measured on the Richter scale and the Mercalli scale.
- The Richter scale is commonly used for measuring an earthquake. While the Richter scale measures the intensity of the earthquake on a scale from 1 to 9, the Mercalli scale measures it on a 12 point scale.
- Earthquakes measured above the Richter scale of 6 onwards cause damage to life and property.

## LEED Zero

### Why in News

India tops globally in LEED Zero certifications of green building projects

### Important Points

- India ranks first globally in LEED Zero certified green building projects surpassing the US and China, according to USGBC and GBCI.
- In India, realty firm DLF and FMCG player ITC are leading in the LEED Zero green certification initiative.
- The LEED Zero projects, including office spaces, hospitality facilities, retail malls, industrial manufacturing projects, and data centres, serve a mix of sectors.
- LEED Zero recognises projects that have reached net zero or net positive status in the categories of carbon, energy, water, or waste.
- US Green Building Council (USGBC) and Green Business Certification Inc (GBCI) said in a statement that India has emerged as a top country with LEED Zero green building projects.
- India has become a global leader in LEED Zero certifications, outperforming both the US and China.
- India has 73 LEED Zero certified projects, comprising 45 per cent of the more than 150 total LEED Zero certifications.
- Haryana and Tamil Nadu are leading the way in certifications.



- The US and China have the second and third most LEED Zero certifications, with 47 (30 per cent) and 15 (10 per cent) certifications, respectively.
- India-based real estate developer DLF is the leader globally in total LEED Zero certifications with 45 certifications, followed by ITC Group with 15 certifications.
- While the private sector is helping India make strides in net zero certifications, nearly one-third of all carbon emissions in India come from the building and construction sector, USGBC and GBCI pointed out.
- India's leadership position in LEED Zero projects reflects its commitment to sustainability and the adoption of innovative green building practices.
- USGBC and GBCI said that the achievement is also in line with India's ambitious target of achieving net zero GHG emissions by 2070.
- A complement to LEED certification, LEED Zero recognises projects that have reached net zero or net positive status in the categories of carbon, energy, water, or waste.
- To date, there are more than 35 million certified square feet of LEED Zero projects.
- USGBC works toward its mission of market transformation through its LEED green building programme, besides other activities.
- Established in 2008, GBCI exclusively administers project certifications and professional credentials and certificates within the framework of the USGBC's Leadership in Energy and Environmental Design (LEED) green building rating systems. It also manages other certifications.



### LEED Zero projects

- LEED has been an essential guide and push for projects that ensure the drastic reduction in greenhouse gas emissions. LEED Zero is a new addition to the LEED certification programs and sustainable goals.
- USGBC launched LEED Zero to address net-zero resources (energy, water, and waste) and net-zero carbon operation in the LEED green building projects.
- Just like the other LEED rating systems, LEED Zero also has set standards and integral goals.
- The primary concern of LEED Zero is to maintain a balanced energy system.
- It doesn't only involve mitigating the impact of building on the environment, but it also focuses on taking it to the next level. This path will help buildings to stand out by maintaining a net-zero impact of carbon and basic resources such as water, waste, and energy.
- LEED Zero highlights outstanding projects' achievements in critical areas to ensure a sustainable environment and a regenerative future.
- This program aims at complementing other LEED rating systems for better results overall.

### Key focus areas of LEED zero certification

#### Types of LEED Zero certification include;

- **LEED Zero Carbon:** LEED Zero Carbon is primarily concerned with carbon emission as a result of building development. Therefore, it focuses on recognizing a building that is operating with net-zero carbon emissions over a year.
- **LEED Zero Energy:** The LEED Zero Energy are for buildings that source net-zero energy balance over one year.
- **LEED Zero Water:** This certification gives recognition to buildings that achieves a potable water use balance of zero over one year.
- **LEED Zero Waste:** This certification recognizes buildings that achieve Green Business Certification Inc's (GBCI) TRUE Zero Waste certification at the platinum level.

#### Benefits of LEED certification

- LEED-certified buildings reduce environmental stress.
- LEED-certified buildings have lower waste generation and energy consumption.
- LEED certification enhances the optimal use of water and other resources.
- LEED-certified buildings have lower operating costs.

## Global Ocean Census

### Why in News

Global Ocean Census aims to find 100,000 marine species in 10 years

### Important Points

- A team of scientists sailed on a research vessel to the chilly waters of the Barents Sea in the Arctic.
- They aim to find new marine species around cold seeps — cracks on the seafloor from which hydrogen sulfide, methane and other gases bubble up.
- Near these fissures, species, including soft corals, glass sponges, sea pens and crustaceans, could be waiting to be discovered.
- Scientists estimate that only about 10% of marine species have been formally described, and about 2 million species have yet to be identified.
- A new global initiative called the Ocean Census aspires to change this.
- The Ocean Census has set an ambitious goal of finding 100,000 new marine species within a decade.
- It intends to do this by sending scientists on dozens of expeditions to marine biodiversity hotspots and using advanced technology like high-resolution imagery, DNA sequencing and machine learning.
- The initiative will undertake seven expeditions in its first year of operation but plans to do even more in the years to come. The first expedition is already underway in the Barents Sea, in partnership with the University of Troms.
- The Ocean Census seeks to bring together many partners from science institutes, businesses, civil society organizations and media to achieve its goals.
- The aim of the Ocean Census is to build upon past efforts to document marine life, such as the Challenger Expeditions, a foundational marine scientific program that took place between 1872 and 1876, as well as the more recent Census of Marine Life, a project that took place between 2000 and 2010.
- It is jointly established by The Nippon Foundation (a non-profit philanthropic organization in Japan) and Nekton Foundation (marine science and conservation institute in the U.K) to discover unknown marine life.
- The Census of Marine Life launched 540 marine expeditions, but scientists found and formally described about 1,200 new marine species; other organisms are still awaiting identification.
- The ocean is critical in regulating the Earth's climate while providing food and livelihoods for billions of people.
- However, the ocean faces a torrent of threats, such as overfishing, pollution and the impacts of climate change, including ocean warming and acidification.



## Decarbonise

### Why in News

Given the significant impact that cities have on the environment, low-carbon cities are crucial to mitigate the effects of climate change.

### Important Points

- By 2050, seven billion people will be living in cities. In 2020 itself, cities dumped 29 trillion tonnes of carbon dioxide into the atmosphere

### Decarbonise urban systems:

- The carbon dioxide along with other greenhouse gases poses a serious health hazard.
- It also manifests as extreme weather events, leading to the loss of lives, livelihoods, assets, and social wellbeing.
- Transitioning to low-carbon or even net-zero cities requires us to integrate mitigation and adaptation options in multiple sectors, including energy, buildings, transportation, industry, and urban land-use.
- This is called the 'sector-coupling approach', and it is necessary to decarbonise urban systems.

### Energy-system transitions:

- An energy-system transition could reduce urban carbon dioxide emissions by around 74%.
- With rapid advancements in clean energy and related technologies and nosediving prices, we have also crossed the economic and technological barriers to implementing low-carbon solutions.
- The transition must be implemented both on the demand and the supply sides.
- Mitigation options on the supply side include phasing out fossil fuels and increasing the share of renewables in the energy mix, and using carbon capture and storage (CCS) technologies.
- On the demand side, using the ‘avoid, shift, improve’ framework would entail reducing the demand for materials and energy, and substituting the demand for fossil fuels with renewables.
- Second, to address residual emissions in the energy sector, we must implement carbon-dioxide removal (CDR) technologies.
- Indeed, we have the appropriate technologies and knowledge base to build net-zero urban systems through energy transitions.

### No one size fit approach:

- Which mitigation and adaptation strategies to implement varies based on some of a city’s characteristics.
- Transitioning to renewable energy sources is not as simple as replacing fossil fuels with clean energy.
- There are multifarious issues of energy justice and social equity to be dealt with.
- This is a key consideration when we frame energy-transition policies that are socially and environmentally fair.
- The considerations are a city’s spatial form, land-use pattern, level of development, and the state of urbanisation.
- An established city can retrofit and repurpose its infrastructure to increase energy efficiency, and promote public as well as active transport like bicycling and walking.
- In fact, walkable cities designed around people can significantly reduce energy demand – as can electrifying public transport and setting up renewables-based district cooling and heating networks.

### Just energy transition:

- Energy systems are directly and indirectly linked to livelihoods, local economic development, and the socio-economic well-being of people engaged in diverse sectors.
- So a one-size-fits-all approach is unlikely to ensure a socially and environmentally just transition.
- For example, transitioning to renewable-energy sources could disproportionately affect groups of people or communities in developing economies and sectors that depend on fossil fuels.
- Broadly, the energy supply needs to be balanced against fast-growing energy demand (due to urbanisation, e.g.), the needs of energy security, and exports.
- Additional justice concerns include -land dispossession related to large-scale renewable energy projects, spatial concentration of poverty, the marginalisation of some communities, gendered impacts, and the reliance on coal for livelihoods.



## Food safety index

### Why in News

5th State Food Safety Index (SFSI) released by Food Safety and Standards Authority of India (FSSAI)

### Important Points

- To encourage States/UTs to improve and work towards food safety in their jurisdiction, the Food Safety and Standards Authority of India releases the State Food Safety Index (SFSI) annually for each financial year on 7th June on the occasion of World Food Safety Day.

### What is the SFSI?

- Developed by the FSSAI, the index aims to measure the performance of states and Union Territories on selected “parameters” of food safety.



- According to the FSSAI, the index is aimed at encouraging states and UTs to “improve their performance and work towards establishing a proper food safety ecosystem in their jurisdiction.
- The Index is a dynamic quantitative and qualitative benchmarking model that provides an objective framework for evaluating food safety across all States/UTs.
- The State Food Safety Index will measure the performance of states on different parameters of Food Safety.
- SFSI aims to foster healthy competition and catalyze positive change in the food safety ecosystem throughout the country, ultimately ensuring the provision of safe and wholesome food to all residents.
- The 1st State Food Safety Index was released in 2019.

#### Scoring Parameters and weightage

- The evaluation sheet of each State/UT was reviewed by Evaluation Committee constituted for the analysis of the performance.
- The general scores and the performance parameters were discussed with States/UTs in the CAC meeting before the release of the index.
- The validated data was used to generate the ranking of States/UTs based on the Scoring Parameters.
- The food safety parameters used to evaluate the performance of States/UTs are broadly classified under following significant factors assigned with separate weightage of marks.

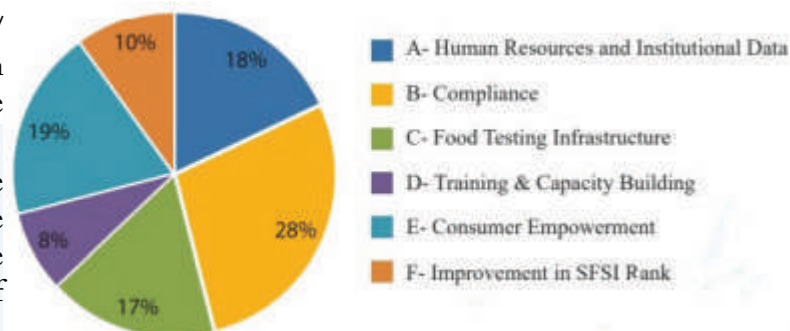

#### Index Rankings:

- Based on the fact that similar States should be compared to ensure comparability among similar entities for the generation of ranks of States/UTs under SFSI, the States/UTs are classified into following categories for the evaluation and assessment:

Categories	Name of States/UTs
Large States (20)	Andhra Pradesh, Assam, Bihar, Chhattisgarh, Gujarat, Haryana, Himachal Pradesh, Jharkhand, Karnataka, Kerala, Madhya Pradesh, Maharashtra, Odisha, Punjab, Rajasthan, Tamil Nadu, Telangana, Uttar Pradesh, Uttarakhand and West Bengal
Small States (8)	Arunachal Pradesh, Goa, Manipur, Meghalaya, Mizoram, Nagaland, Sikkim and Tripura
Union Territories (UTs) (8)	Andaman and Nicobar Islands, Chandigarh, Dadra and Nagar Haveli and Daman and Diu, National Capital Territory of Delhi, Jammu and Kashmir, Lakshadweep, Ladakh and Puducherry.

#### 5th State Food Safety Index:

Category- Union Territories	
Name	Rank
Jammu & Kashmir	1
Delhi	2
Chandigarh	3

Category- Small States	
Small State	Rank
Goa	1
Manipur	2
Sikkim	3

Category- Large States	
Large State	Rank
Kerala	1
Punjab	2
Tamil Nadu	3

#### Key highlight of report

- Similar states are compared in categories of Large states (20), small states (8) and UTs (8)
- Top performers in 5th edition were Kerala (Large states), Goa (small state) and J&K (UTs).
- The report highlights specialised testing labs and trained food safety officers along with multiple efforts are initiated.

## Vienna Declaration

### Why in News

30th Anniversary Of The Vienna Declaration And Programme Of Action

### Important Points

- This year (2023) marks the 30th anniversary of the Vienna Declaration and Programme of Action.
- The Vienna Declaration and Programme of Action (VDPA) is a human rights declaration adopted by consensus at the World Conference on Human Rights on 25 June 1993 in Vienna, Austria.
- Throughout 2023, UN Human Rights is celebrating Human Rights 75 initiative to call on States and all others to take clear steps to fulfil the promises of the Universal Declaration.

### Main features of declaration:

- It affirmed the universality, indivisibility and interdependency of human rights.
- Vienna's Right of self-determination to freely determine their political status, and freely pursue their economic, social and cultural development
- Fight against impunity, including the establishment of the International Criminal Court (ICC).

### Action Plan:

- The position of United Nations High Commissioner for Human Rights was recommended by this Declaration and subsequently created by General Assembly
- World Conference on Human Rights recommended that each State consider the desirability of drawing up a national action plan for the protection of human rights.
- United Nations Human Rights Council holds regular debates (under its agenda item 8) on follow-up.
- However, new challenges are holding back fulfilment of UDHR and VDPA, among these, digitalization and climate change, inequalities, gender discrimination, and a rise in hate speech, disinformation and polarization.

### UDHR (1948):

- The Universal Declaration of Human Rights (UDHR), adopted in 1948, sets out a common standard of human rights for people worldwide, regardless of their nationality, race, religion, or other status.
- It consists of two treaties i.e. International Covenant on Civil and Political Rights (ICCPR) and International Covenant on Economic, Social and Cultural Rights (ICESCR) adopted in 1966.
- Together with UDHR, ICCPR and ICESCR comprise the International Bill of Human Rights.

## Asia Pacific Plant Protection Commission

### Why in News

The Asia Pacific Plant Protection Commission unanimously elected India as chair of the Standing Committee on Integrated Pest Management (IPM) for the biennium 2023-24 during the 32nd Session held in Bangkok.

### Important Points

#### Background:

- The Asia Pacific Plant Protection Commission is an intergovernmental organization established in 1956 under the approval of the Food and Agriculture Organization (FAO) of the United Nations.
- Its purpose is to foster collaboration among countries in the Asia-Pacific region to enhance plant health and protection.

#### Membership:

- The commission comprises 25 member countries, including India, with each country represented by its delegates.

#### Organizational Structure:

- The commission's structure involves the participation of representatives from all member countries. A Chairperson, elected from among the members, serves for a two-year term.
- The Director-General of the FAO appoints and supports the secretariat responsible for coordinating, organizing, and overseeing the commission's work.

#### Meetings:

- The commission convenes at least once every two years, providing an opportunity for all member countries to participate.

**Objectives:**

- The primary objectives of the commission include coordinating and supporting plant protection activities among its member countries in the Asia-Pacific region.
- It focuses on developing regional standards for phytosanitary measures (RSPMs) and other relevant initiatives to safeguard plant health and promote sustainable agricultural practices.

**Hindu Kush Himalayas****Why in News**

According to a new report from International Centre for Integrated Mountain Development (ICIMOD), the Hindu Kush Himalayas (HKH) have seen a 65 per cent faster loss of glacier mass

**Important Points****Hindu Kush Himalayas (HKH) Region:**

- These are the mountain ranges stretching over 3500 kilometres and across eight countries – Afghanistan, Bangladesh, Bhutan, China, India, Nepal, Myanmar and Pakistan.
- The Hindu Kush Himalaya is arguably the world's most important 'water tower', being the source of ten of Asia's largest rivers as well as the largest volume of ice and snow outside of the Arctic and Antarctica.
- Together these rivers support the drinking water, irrigation, energy, industry and sanitation needs of 1.3 billion people living in the mountains and downstream.

**About the Report**

- The glaciers lost a mass of 0.28 metres of water equivalent per year (m w.e.) between 2010 and 2019 compared to 0.17 (m w.e.) per year between 2000 and 2009, the Water, Ice, Society, and Ecosystems in the Hindu Kush Himalaya (HI-WISE) report noted.
- The Karakoram range, which was known to be stable, has also started showing a decline in glacier mass, losing 0.09 m w.e. per year during 2010-2019.
- The average temperature in the region has increased by 0.28°C per decade between 1951 and 2020.
- Nine out of 12 river basins have witnessed increased warming rates at higher elevations. The strongest impacts are being felt in the Brahmaputra, Ganges, Yangtze, and Indus Basins.
- In a business-as-usual scenario, HKH glaciers could lose up to 80 percent of their current volume by 2100, the report highlighted.
- Further, a quarter of snow cover could be lost under a high emissions scenario.
- The report quoted a study that predicted a decline in snowfall by 30-50 per cent in the Indus Basin, 50-60 per cent in the Ganges, and 50-70 per cent in the Brahmaputra between 2070 and 2100 compared to the average snowfall between 1971 and 2000.

**Importance of the Hindu Kush Himalayas**

- Glaciers occupy an area of approximately 73,173 square kilometres (km<sup>2</sup>) in the HKH, which helps to maintain the ecological balance in the region.
- The biodiversity of the region — 40 percent of which is under protected areas — is dependent on the cryosphere as it is an important source of water for maintaining ecosystem health, supporting biological diversity, and providing ecosystem services.
- Ice and snow in the HKH are an important source of water for 12 rivers that flow through 16 countries in Asia.
- About 240 million people are in the mountains and 1.65 billion downstream are dependent on them.

**About International Centre for Integrated Mountain Development (ICIMOD)**

- It is an intergovernmental knowledge and learning centre working on behalf of the people of the Hindu Kush Himalaya (HKH).
- It is based in Kathmandu, Nepal.
- It works for eight regional member countries – Afghanistan, Bangladesh, Bhutan, China, India, Myanmar, Nepal, and Pakistan.

**Functions**

- It serves the region through information and knowledge generation and sharing to find innovative solutions to critical mountain problems.
- It bridges science with policies and on-the-ground practices.



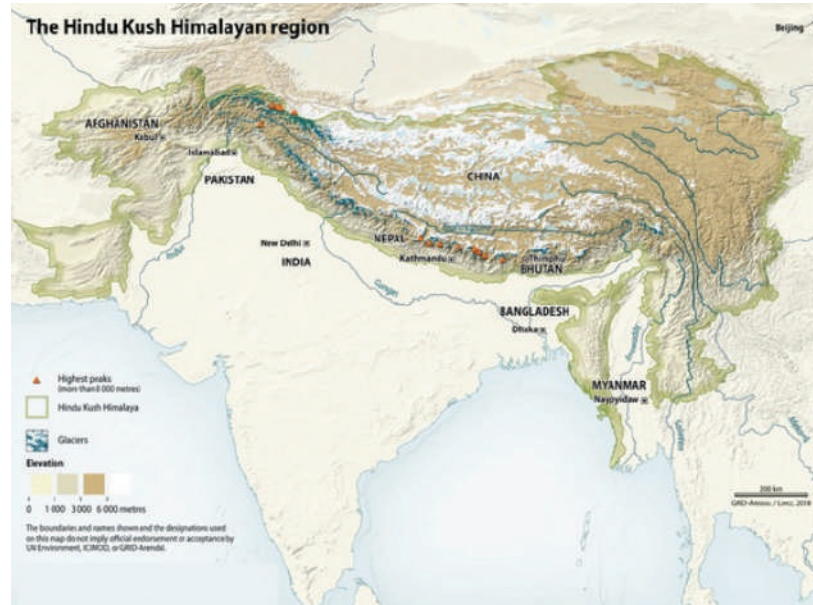

- It provides a regional platform where experts, planners, policymakers, and practitioners can exchange ideas and perspectives towards the achievement of sustainable mountain development.

## Bonn Climate

### Why in News

The Bonn climate change conference recently finished was built up as an opportunity for course correction.

### Important Points

- With current global efforts to keep rising temperatures in check abysmally inadequate, a massive and immediate scale-up in climate action is essential to keep alive any realistic chance of meeting the 1.5 degree or 2 degree Celsius targets.
- Bonn was expected to act as the springboard for accelerated action.
- But just like the more famous year-ending climate conferences, Bonn underperformed. Developed and developing countries bickered on issues old and new, and could not even agree on the agenda of one of the meetings till the penultimate day.

### Global Stocktake

- One thing that the countries did manage to wrap up, however, was the third and final round of technical discussions on global stocktake, or GST.
- Mandated by the 2015 Paris Agreement, GST is an exercise aimed at assessing the progress in the fight against climate change, and deciding ways and means to enhance global action to bridge the adequacy gap. The Paris Agreement says GST must be conducted every five years, starting in 2023.
- The actual meat in GST would come in at COP28, the year-ending climate conference, this time being held in Dubai. The technical discussions just produced a short 'framework' on the elements to be included in the stocktake exercise. Even this saw repeated squabbling between the developed and developing countries, mainly over provisions related to finance and 'historical responsibility' of the rich countries.
- A bulk of the accumulated greenhouse gas emissions, the reason for global warming, have come from a group of about 40 rich and industrialised countries, usually referred to as Annex I countries because they were mentioned in Annexure I of the 1992 UN Framework Convention on Climate Change, or UNFCCC.

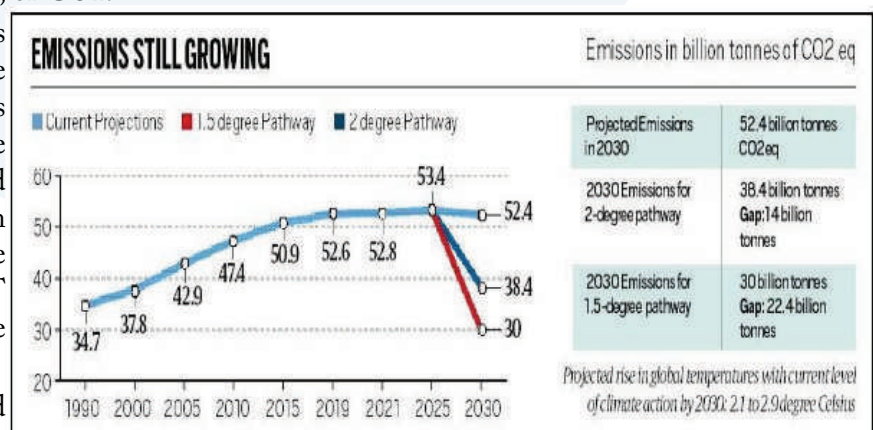

## Money matters

- Apart from GST, another mechanism was set up at COP26 in Glasgow in 2021 for climate action. Called Mitigation Work Programme (MWP), this is a temporary emergency exercise focused only on increasing emission cuts.
- The Intergovernmental Panel on Climate Change says global emissions have to come down by 43% from 2019 levels by 2030 to keep alive hopes of meeting the 1.5 degree target.
- As of now, emissions are still growing and, in 2021, were higher than 2019 levels.
- Developed countries are under an obligation to support the implementation of climate action plans of developing countries through money and tech transfers. But money has been in perennial short supply.
- According to one assessment, developing countries need as much as US\$ 6 trillion between now and 2030 just to implement their climate action plans.
- The loss and damage needs of developing countries are assessed to be about US\$ 400 billion every year.
- More funds are needed for all kinds of other purposes, the total estimated to be running in several trillions of dollars every year.
- Against this, even a minuscule-looking US\$ 100 billion per year that the developed countries had committed to raise from 2020 is not fully available.

## Meeting in Paris

- A fresh effort at raising financial resources for climate change is being made in Paris with a two-day meeting that several heads of states are slated to attend.
- The Summit for a New Global Financial Pact is an attempt at redirecting global financial flows and raising new money to fight climate change, and dealing with associated problems like biodiversity loss and poverty.

## Auroras

### Why in News

Researchers have for the first time analysed data of “carbon dioxide auroras” taken from space.

### Important Points

- The Northern Lights, or auroras are a phenomenon as fascinating as they are beautiful, captivating everyone from scientists to everyday starwatchers.
- While they have been studied in detail, not much is known about auroras associated with carbon dioxide molecules. That might change now.
- The word aurora might conjure up images of splendid green and sometimes red lights pirouetting across the sky.
- But auroras are associated with many different kinds of electromagnetic emissions that occur in the atmosphere.
- Most of these emissions are not visible to the unaided human eye.

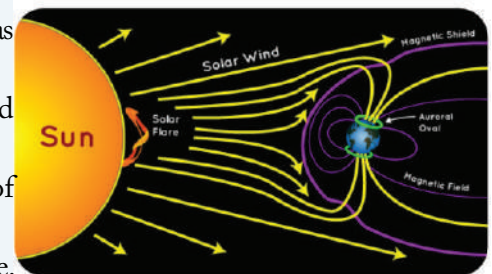

### About Auroras

- Formation: When charged particles like electrons and protons collide with the gases in Earth's upper atmosphere, they produce tiny flashes of colourful light, what we know as auroras.
- In the Northern Hemisphere, the phenomenon is called the northern lights (aurora borealis), while in the Southern Hemisphere, it's called the southern lights (aurora australis).
- The hemispheric asymmetry of the aurora is due in part to the sun's magnetic field interfering with Earth's magnetic field.
- The usually observed green and red auroras happen between 100 kilometres and 250 kilometres above the surface of the planet due to an excited state of atomic oxygen.

### Carbon Dioxide Aurora

- When charged particles crash into the planet's atmosphere, they interact with many different atoms and molecules. Carbon dioxide is one of them.
- While the gas is known for acting as a greenhouse gas due to its presence in the lowest part of the atmosphere, trace parts of carbon dioxide also exist in the atmosphere at the edge of space.
- When carbon dioxide molecules about 90 kilometres above Earth become excited during an aurora, they emit infrared radiation.
- This leads to more infrared radiation than is typically observed in the planet's atmosphere.

## SEBI

### Why in News

SEBI proposes additional disclosure for high-risk foreign portfolio investors

### Important Points

- The Securities and Exchange Board of India (SEBI) released a consultation paper on framework for mandating additional disclosures from Foreign Portfolio Investors (FPIs) especially those who have either concentrated single group exposures or significant overall holdings in their equity investment portfolio.
- The paper said that some FPIs have been observed to concentrate a substantial portion of their equity portfolio in a single investee company/ company group. In some cases, these concentrated holdings have also been near static and maintained for a long time.
- Such concentrated investments in a single investee company or group raise the concern and possibility that promoters of such corporate groups, or other investors acting in concert, could be using the FPI route for circumventing regulatory requirements such as that of maintaining Minimum Public Shareholding (MPS), the consultation paper said.
- If this were the case, the apparent free float in a listed company may not be its true free float, increasing the risk of price manipulation in such scrips, it said.
- “To mitigate the risk of circumvention of regulations such as MPS, and to prevent potential misuse of the FPI route to circumvent, it is proposed that enhanced transparency measures for fully identifying all holders of ownership, economic, and control rights may be mandated for certain objectively identified high-risk FPIs that fulfil certain criteria,” the consultation paper said.

#### LOOKS TO THWART STOCK PRICE MANIPULATION

Concentrated investments raise the concern and possibility that promoters of such corporate groups, or other investors acting in concert, could be using the FPI route for circumventing regulatory requirements such as that of maintaining minimum public shareholding —SEBI CONSULTATION PAPER

Sebi said that in such cases, the apparent free float in a listed co may not be its true free float, which in turn could increase the risk of price manipulation

#### Move Comes After Adani Probe

The move comes after four Mauritius-based FPIs were found to have invested almost all of their capital in Adani Group stocks.

In a subsequent probe, Sebi was unable to zero in on the ultimate owners of large investments in Adani Group companies' stocks

### Categorize FPIs

- The paper has proposed to categorize FPIs into high, moderate and low risk. All FPIs except for government and government related entities such as central banks, sovereign wealth funds, and pension funds or public retail funds will be categorized as high risk FPIs.
- It said that such disclosures must be unconstrained by any materiality thresholds set by the PMLA (Prevention of Money Laundering) rules and FPI regulations.
- For prevention of circumvention of MPS, the SEBI's consultation paper has proposed that high-risk FPIs, holding more than 50 per cent of their equity Asset Under Management (AUM) in a single corporate group, would be required to comply with the requirements for additional disclosures.
- FPIs with a single India/ India-related corporate group exposure below 25 per cent of their overall AUM at a scheme level may be reclassified as moderate risk and may therefore be exempt from any requirements of additional disclosures, the paper said.
- It said that the new FPIs that have just begun investments will be allowed to cross the 50 per cent group concentration threshold up to a period of six months without the need for additional disclosures. Beyond 6 months, however, any crossing of the 50 per cent concentration threshold by such FPIs will trigger the requirement for additional disclosures.
- The need for additional disclosures will not apply in cases where existing FPIs that are in the process of winding down their investments. They may temporarily breach the 50 per cent investment threshold in a single corporate group, provided that the portfolio of such FPIs is wound down within six months, it said.



- Existing high-risk FPIs that have more than the 50 per cent concentration threshold in a single corporate group will be provided a window of six months to bring down such exposure below 50 per cent, before the need for additional disclosure requirements become effective.
- The paper proposed that existing high-risk FPIs with an overall holding in Indian equity markets of over Rs 25,000 crore will be required to comply with additional granular disclosure requirements within 6 months, failing which the FPI should bring down its AUM below the threshold.
- High-risk FPIs that cross the Rs 25,000 crore AUM threshold in the future will be required to comply with additional granular disclosure requirements within 3 months of the event, failing which the FPI should bring down its AUM below the threshold within the time frame.

### About SEBI

- The Securities and Exchange Board of India was constituted as a non-statutory body on April 12, 1988 through a resolution of the Government of India.
- The Securities and Exchange Board of India was established as a statutory body in the year 1992 and the provisions of the Securities and Exchange Board of India Act, 1992 (15 of 1992) came into force on January 30, 1992.

### Objectives of SEBI

1. Investor Protection: This is one of the most important objectives of setting up SEBI. It involves protecting the interests of investors by providing guidance and ensuring that the investment done is safe.
2. Preventing the fraudulent practices and malpractices which are related to trading and regulation of the activities of the stock exchange
3. To develop a code of conduct for the financial intermediaries such as underwriters, brokers, etc.
4. To maintain a balance between statutory regulations and self regulation.

### Functions of SEBI

- To protect the interests of Indian investors in the securities market.
- To promote the development and hassle-free functioning of the securities market.
- To regulate the business operations of the securities market.
- To serve as a platform for portfolio managers, bankers, stockbrokers, investment advisers, merchant bankers, registrars, share transfer agents and others.
- To regulate the tasks entrusted to depositors, credit rating agencies, custodians of securities, foreign portfolio investors and other participants.
- To educate investors about securities markets and their intermediaries.
- To prohibit fraudulent and unfair trade practices within the securities market and related to it.
- To monitor company takeovers and acquisition of shares.
- To keep the securities market efficient and up to date through proper research and developmental tactics.

### Powers of SEBI

#### Quasi-Judicial Power

- In cases of fraud and unethical practices in the securities market, SEBI India can pass judgements.
- The said power of SEBI facilitates transparency, accountability and fairness in the securities market.

#### Quasi-Executive Power

- SEBI can examine the Book of Accounts and other vital documents to identify or gather evidence against violations. If it finds one violating the regulations, the regulatory body can impose rules, pass judgements and take legal actions against violators.

#### Quasi-Legislative Power

- To protect the interest of investors, the authoritative body has been entrusted with the power to formulate pertinent rules and regulations. Such rules tend to encompass listing obligations, insider trading regulations and essential disclosure requirements.
- The body formulates rules and regulations to eliminate malpractices in the securities market.
- The Supreme Court of India and the Securities Appellate Tribunal have the upper hand when it comes to the powers and functions of SEBI. The two apex bodies must go through all their functions and related decisions.

## Arbitration Law

### Why in News

Centre forms expert committee to suggest reforms to arbitration law

### Important Points

- The formation of the expert committee to recommend reforms to the Arbitration and Conciliation Act, 1996, marks a significant milestone in India's pursuit of an efficient and party-driven arbitration.
- The Indian government, through the Department of Legal Affairs, has taken a significant step towards improving the arbitration process by forming an expert committee.
- Led by former law secretary T K Vishwanathan, the committee aims to recommend reforms to the Arbitration and Conciliation Act of 1996. With a focus on reducing court intervention, enhancing cost-effectiveness, and ensuring timely resolution, the committee is expected to submit its recommendations within 30 days.

### Examining the Working of the Act:

- One of the primary objectives of the expert committee is to thoroughly examine the functioning of the Arbitration and Conciliation Act, 1996. By assessing its strengths, weaknesses, and challenges in comparison to foreign jurisdictions, the committee seeks to identify areas for improvement. This critical analysis will serve as a foundation for drafting proposed amendments and making other recommendations to the government.

### Limiting Judicial Intervention:

- To make arbitration a truly party-driven process, the committee aims to propose solutions that limit the requirement for parties to seek judicial intervention. By addressing this issue, the committee aims to streamline the arbitration process and minimize delays caused by court involvement. The objective is to create a more efficient and time-bound framework for resolving disputes through arbitration.

### Expediting Finality of Awards:

- Another significant aspect the committee will address is the expeditious attribution of finality to arbitral awards. By suggesting modifications to existing provisions related to setting aside awards and appeals, the committee aims to facilitate the swift enforcement of arbitration awards. This will provide parties with the assurance of a conclusive resolution to their disputes.

### Developing a Competitive Environment:

- The expert committee recognizes the importance of creating a competitive environment in the arbitration services market. To this end, the committee will recommend a framework for a model arbitration system that fosters healthy competition. By attracting both domestic and international parties, this framework will enhance India's standing as a preferred destination for arbitration.

### Minimizing Reliance on Judicial Authorities:

- One of the key objectives of the committee is to suggest a statutory means to minimize reliance on judicial authorities and courts. By establishing an administrative mechanism and standard operating procedures, the committee aims to reduce routine challenges to arbitral awards involving the government. This will streamline the arbitration process, providing parties with a more efficient and reliable means of dispute resolution.

### Cost Determination and Charter of Duties:

- The committee will also focus on determining the costs of arbitration and fees of arbitrators. By recommending principles for cost calculation, the committee aims to bring transparency and fairness to the arbitration process. Additionally, a charter of duties will be devised to guide the conduct of arbitral tribunals, parties, and arbitral institutions, further enhancing the efficiency and effectiveness of arbitration proceedings.

### Separate Laws for Domestic and International Arbitration:

- The committee will evaluate the feasibility of enacting separate laws for domestic and international arbitration. By considering the unique requirements of each category, the committee aims to provide a robust legal framework that caters to the specific needs of both domestic and international arbitration. Furthermore, templates for model arbitration agreements and awards will be recommended for adoption by parties and arbitrators.

### Simplifying Arbitration Legislation and Standardizing Functions:

- To promote accessibility and clarity, the committee will explore the need for new legislation on arbitration in simple language. By developing a handbook for arbitrators, the committee seeks to standardize their functions and provide comprehensive guidance. These measures will enhance the professionalism and consistency of arbitration proceedings.

# Remittance

## Why in News

Remittance inflows growth could slow to just 0.2% in 2023

### Important Points

- Recently, the latest edition of the Migration and Development brief released by the World Bank revealed that growth in remittance inflows into India could slow to 0.2% in 2023 from more than 24% in 2022.
- The slower growth in the Organisation for Economic Co-operation and Development (OECD) economies was limiting employment and wage gains for migrants leading to a slowdown in remittances,
- In other regions such as East Asia and the Pacific, and Sub-Saharan Africa, the growth rate for remittances in 2023 is projected to be around 1%.
- Slower growth in OECD economies — especially in the high-tech sector in the United States that could affect the demand for information technology (IT) workers and lead to a diversion of formal remittances toward informal money transfer channels — is likely to impact the flow of remittances in 2023.
- India, which registered a growth of more than 24% to reach a record-high \$111 billion in remittances in 2022, is expected to post a growth of just 0.2% in remittance inflows in 2023, according to the World Bank's latest Migration and Development Brief.
- The Organisation for Economic Co-operation and Development (OECD) is a grouping of 38 high-income democratic countries.
- A lower demand for migrants in the Gulf Cooperation Council (GCC) countries, a grouping of six Arab nations located around the Arabian Gulf where declining oil prices have dented growth, is another key contributing factor.

### World Bank Report

- World Bank's Migration and Development Brief, slower growth in the OECD economies is likely to impact the flow of remittances in 2023.
- This is clearly evident in high-tech sectors in countries like the U.S.A., affecting the demand for IT workers and a diversion of formal remittances to informal money transfer channels.
- Lower demand for migrant workers in the Gulf Cooperation Council (GCC) countries, where growth has been impacted by the decline in oil prices, is another key factor in the decline in remittances.
- In the previous edition of the Migration and Development Brief in November 2022, a record \$100 billion in remittance inflows had been estimated by the World Bank for India in 2022. This has been revised up to \$111 billion in June 2023.
- The revision is a result of the strong labor market conditions and hikes in wages observed in the high-income destination economies, as well as the higher energy prices in the GCC countries.

## Why remittance inflows growth could slow to just 0.2% in 2023

A World Bank brief projects India's remittance\* inflows to grow by just **0.2%** in **2023**, a **dramatic slowing from 2022**, when they grew by more than **24%** to reach a record **\$111 billion**. **Why would this happen?**



\*Remittances are funds transferred from migrants to their home country.

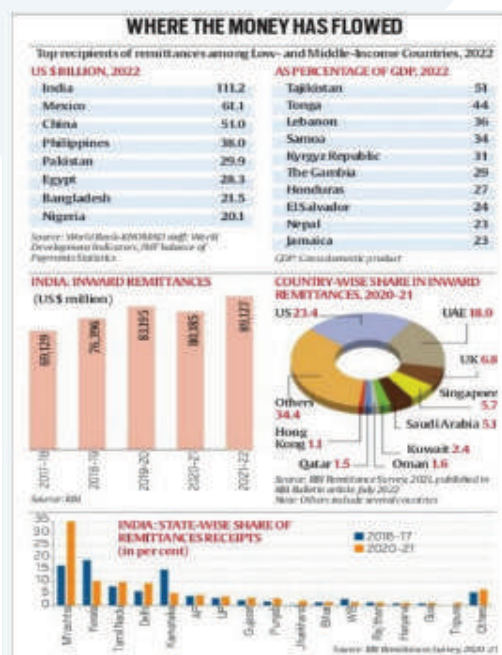



### Why are remittances important?

- Remittances are the second most important source of financing behind FDI for middle and low-income developing countries.
- It has a significant impact on household finances and contributes to asset building as well as improving the quality of life of citizens.
- They act as a complement to cash transfer schemes of the government and are an essential aspect of household incomes, especially during difficult times.
- Remittances are a critical source of foreign exchange and an important financial inflow for most countries following the worst impacts of the Covid-19 pandemic.
- Remittances were almost 326% of FDI inflows in 2022, rising from 247% in 2019; and 1,036% of official development assistance compared to 935% in 2019.
- According to the head of the World Bank KNOMAD (Global Knowledge Partnership on Migration and Development), remittances are a major source of finance for most countries since the pandemic and are expected to become an increasingly important component of economies.
- Remittances accounted for just 4% of South Asia's GDP (2022), and individually 23.1% of Nepal's GDP, 7.9% of Pakistan's, 5.1% of Sri Lanka's, 4.7% of Bangladesh, and 3.3% of India's GDP.
- In comparison, remittance inflows form a substantial portion of the GDP of countries like Tajikistan (51%), Tonga (44%), Lebanon (35%), Samoa (34%), and the Kyrgyz Republic (31%).

### Where does India receive remittances from?

- The advanced economies i.e. the U.S.A., Europe, Canada, South Africa, etc accounted for 30% of India's total migrant stock with the GCC region behind it.
- According to the RBI's Headwinds of COVID-19 and India's Inward Remittances report, the compositional shift in India's migrants to more high-skilled white-collar workers is a good sign for inward remittances.
- RBI survey data revealed that the share of traditional remittance recipient states like Kerala and Karnataka dropped sharply between 2016-17 and 2020-21.
- While Kerala was the top recipient state in 2016-17, Maharashtra has emerged as the top recipient state in 2020-21.
- The reasons for the changes include the changing dynamics of the host country, reducing wage differentials, and changing occupational patterns such as the increase in white-collar workers and the arrival of low-wage semi-skilled workers from other states and countries.
- The RBI report found that migration to the GCC from states like Uttar Pradesh, Bihar, Odisha, and West Bengal has increased in recent years.

## TREDS

### Why in News

Integration of GSTN with trade receivables discounting system (TREDS) via account Aggregator

### Important Points

- The government and Reserve Bank of India (RBI) are looking to integrate GSTN (Goods and Services Tax Network) with TReDS (Trade Receivables Discounting System) platforms to enable direct sanctions of MSME invoices.
- Integration will ensure that e-invoices raised by MSMEs on GSTN can come directly to the TReDS portal, thus negating the need for any additional activity or documentation.
- It could greatly improve the working of TReDS platforms over a period of time.
- It will also lead to faster loan underwriting and sanctions as sourcing directly from the GST platform will provide more assurance and comfort to financiers with respect to the genuineness of invoices.
- In addition, it will help build an alternative credit database, especially for MSMEs with weak or minimal credit history.

### What is an Account Aggregator?

- An Account Aggregator (AA) is a type of RBI regulated entity (with an NBFC-AA license) that helps an individual securely and digitally access and share information from one financial institution they have an account with to any other regulated financial institution in the AA network. Data cannot be shared without the consent of the individual.

- There will be many Account Aggregators an individual can choose between.
- Account Aggregator replaces the long terms and conditions form of 'blank cheque' acceptance with a granular, step by step permission and control for each use of your data.

### The Account Aggregator is an interoperable **data blind** Consent Manager

AAs **cannot read** consumer data.  
They **cannot resell** consumer data.

AAs enable consumers to selectively **share & even revoke data** once shared.

AAs have a fiduciary duty to consumers and are **RBI regulated entities**, sharing **digitally signed & encrypted data**



### Account Aggregator Ecosystem in India



### Secondary window

- Vendor data and invoice will flow through the platform, thereby helping us audit in a better way and also form a better data view of the vendor.
- So it will be very handy as a secondary window as we keep adding data, as we would have GST data as well as the actual performance on the platform.
- This will also help financiers use this data for other distribution models.
- The GST network is likely to be integrated through the account aggregator model to ensure data privacy and security.
- Discussions are coming to the conclusion that invoices can come through the GST platform, but through AA (account aggregator) model.
- GSTN will be registered as FIP (Financial Information Provider) and TReDS platforms as FIU (Financial Information User) and so they will get all the invoices.
- In February 2021, the Standing Committee on Finance headed by Jayant Sinha had recommended the integration of TReDS platform with GSTN e-invoicing portal to allow real time sharing of data through a single window of access to authenticated invoices.
- However, so far, no decision has been taken due to operational, implementation challenges and data sharing concerns.

### Better integration

- Now there are discussions on integration with all digital public infrastructure including GSTN, Udyam platform for registration and the government e-marketplace (GeM) portal.
- Either these will happen directly with the TReDS platforms if the government allows it, or then through an account aggregator.
- Such integrations will also help the government track the invoices being created, and the sanction and rejection rates, thus encouraging more central PSU companies to participate in TReDS.
- CPSEs are not coming in so far but we have been seeing demand from States. This should only improve with the integration of the government portals.
- Goa and Tamil Nadu are already active, and Madhya Pradesh, Uttar Pradesh and Haryana are expected to join TReDS soon.

### How will the new Account Aggregator network improve an average person's financial life?

- India's financial system involves many hassles for consumers today -- sharing physical signed and scanned copies of bank statements, running around to notarise or stamp documents, or having to share your personal username and password to give your financial history to a third party.
- The Account Aggregator network would replace all these with a simple, mobile-based, simple, and safe digital data access & sharing process.

- This will create opportunities for new kinds of services -- eg new types of loans.
- The individual's bank just needs to join the Account Aggregator network.
- Currently 23 banks are under AA both public and private.

**Account Aggregator empowers the individual with control over their personal financial data, which otherwise remains in silos**

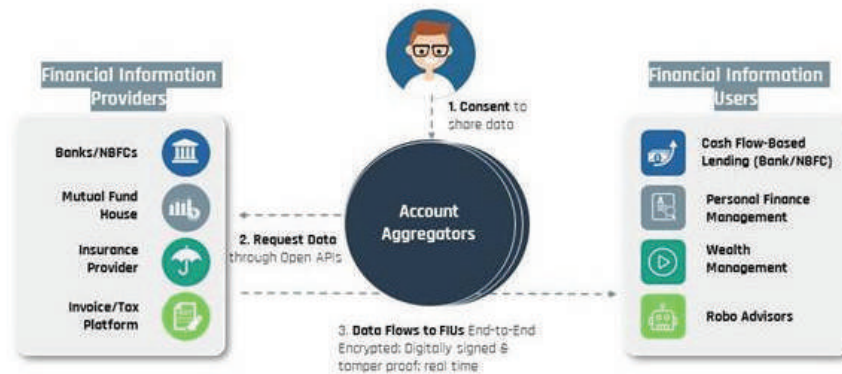

### What is TReDS?

- TReDS is an electronic platform for facilitating the financing / discounting of trade receivables of Micro, Small and Medium Enterprises (MSMEs) through multiple financiers.
- These receivables can be due from corporates and other buyers, including Government Departments and Public Sector Undertakings (PSUs).
- TReDS is a payment system authorised under the PSS Act.
- It is a platform for uploading, accepting, discounting, trading and settling invoices / bills of MSMEs and facilitating both receivables as well as payables factoring (reverse factoring).
- MSME sellers, corporate and other buyers, including Government Departments and PSUs, and financiers (banks, NBFC-Factors and other financial institutions, as permitted) are direct participants in the TReDS and all transactions processed under this system are "without recourse" to MSMEs.
- Initially, three entities were authorised to operate TReDS.
- To encourage innovation and competition through increased participation, 'on-tap' authorisation was introduced in October 2019.
- New players would be authorised considering the merits of the proposal and assessment of potential for additional entities.

### Who are the participants in TReDS?

- Sellers, buyers and financiers are the participants on a TReDS platform.

### Who can participate as a seller in TReDS?

- Only MSMEs can participate as sellers in TReDS.

### Who can participate as a buyer in TReDS?

- Corporates, Government Departments, PSUs and any other entity can participate as buyers in TReDS.

### Who can participate as a financier in TReDS?

- Banks, NBFC - Factors and other financial institutions as permitted by the Reserve Bank of India (RBI), can participate as financiers in TReDS.

### How does TReDS work?

- Creation of a Factoring Unit (FU) - standard nomenclature used in TReDS for invoice(s) or bill(s) of exchange - containing details of invoices / bills of exchange (evidencing sale of goods / services by the MSME sellers to the buyers) on TReDS platform by the MSME seller (in case of factoring) or the buyer (in case of reverse factoring);
- Acceptance of the FU by the counterparty - buyer or the seller, as the case may be;
- Bidding by financiers;
- Selection of best bid by the seller or the buyer, as the case may be;
- Payment made by the financier (of the selected bid) to the MSME seller at the agreed rate of financing / discounting;
- Payment by the buyer to the financier on the due date.



## PPIs

### Why in News

Deposit Insurance cover for Prepaid Payment Instruments (PPIs)

### Important Points

- Prepaid Payment Instrument (PPI) holders may soon get protection for their money against any fraud or unauthorised payment transactions.
- A committee set up to review the Customer Service Standards in RBI Regulated Entities has recommended that the central bank should examine the extension of Deposit Insurance and Credit Guarantee Corporation (DICGC) cover to PPIs, which, at present, is available only to bank deposits.
- If the committee's recommendation is accepted, it will come as a big relief for PPI holders.

### What are PPIs?

- PPIs are instruments that facilitate the purchase of goods and services, conduct of financial services and enable remittance facilities, among others, against the money stored in them.
- PPIs can be issued as cards or wallets.
- There are two types of PPIs – small PPIs and full-KYC (know your customer) PPIs. Further, small PPIs are categorized as – PPIs up to Rs 10,000 (with cash loading facility) and PPIs up to Rs 10,000 (with no cash loading facility).
- PPIs can be loaded/reloaded by cash, debit to a bank account, or credit and debit cards.
- The cash loading of PPIs is limited to Rs 50,000 per month subject to the overall limit of the PPI.

### Who can issue PPI instruments?

- PPIs can be issued by banks and non-banks after obtaining approval from the RBI.
- As on now over 58 banks including Airtel Payments Bank, Axis Bank, Bank of Baroda, Jio Payments Bank, Kotak Mahindra Bank, Standard Chartered Bank, UCO Bank and Union Bank have been permitted to issue and operate prepaid payment instruments.
- There are 33 non-bank PPI issuers.
- Some of the non-bank PPI issuers are Amazon Pay (India), Bajaj Finance, Delhi Metro Rail Corporation Ltd, Manappuram Finance Ltd, Ola Financial Services, Razorpay Technologies and Sodexo SVC India Pvt.

### What has the RBI committee recommended?

- The committee said the RBI has authorised a number of banks and non-banks entities to issue PPIs in the country recently. The money kept in wallets is in the nature of deposits. However, currently, the DICGC cover extends only to bank deposits.
- Being deposits with the PPI issuers who are also regulated by the Reserve Bank, extending deposit insurance to the PPI segment needs examination, the RBI-appointed committee recommended.
- The Reserve Bank may examine whether Deposit Insurance and Credit Guarantee Corporation (DICGC) cover can be extended to bank PPIs and later to nonbank PPIs based on experience gained.

### What is DICGC?

- DICGC is a wholly-owned subsidiary of the RBI and provides deposit insurance.
- The deposit insurance system plays an important role in maintaining the stability of the financial system, particularly by assuring the small depositors of the protection of their deposits in the event of a bank failure.
- The deposit insurance extended by DICGC covers all commercial banks including local area banks (LABs), payments banks (PBs), small finance banks (SFBs), regional rural banks (RRBs) and co-operative banks, that are licensed by the RBI.

### What does the DICGC insure?

- DICGC insures all deposits such as savings, fixed, current and recurring including accrued interest.
- Each depositor in a bank is insured up to a maximum of Rs 5 lakh for both principal and interest amount held by them as on the date of liquidation or failure of a bank.
- The earlier insurance cover provided by DICGC was Rs one lakh. However, the limit of insurance cover for depositors in insured banks was raised to Rs 5 lakh in 2020.

### What is the total number of PPIs in the system?

- As per the recent RBI data, the total number of PPIs stood at 16,185.26 lakh as on March 31, 2023.
- Of this, the number of wallets was nearly 1,3384.68 lakh and the number of cards was 2800.58 lakh. In FY2023, the total volume transacted through PPIs was 74,667.44 lakh.

## Antardrishti

### Why in News

RBI Governor Launches Financial Inclusion Dashboard 'Antardrishti'

#### Important Points

- RBI Governor Shaktikanta Das recently unveiled a new financial inclusion dashboard called 'Antardrishti.' The dashboard aims to provide valuable insights and track the progress of financial inclusion by capturing relevant data. This initiative further reinforces the RBI's commitment to promoting financial inclusion through a collaborative approach involving multiple stakeholders.

#### Assessing Financial Exclusion at a Local Level

- One of the key features of the 'Antardrishti' dashboard is its ability to assess the extent of financial exclusion at a local level across the country. By identifying areas with higher levels of financial exclusion, policymakers can focus on implementing targeted measures to address these gaps and promote greater financial inclusivity.

#### Internal Use and Multi-Stakeholder Approach

- Initially designed for internal use within the RBI, the 'Antardrishti' dashboard is expected to play a crucial role in facilitating financial inclusion. By adopting a multi-stakeholder approach, the dashboard aims to involve various entities such as government agencies, regulators, and financial institutions in the collective effort to enhance financial inclusion in India.

#### The Financial Inclusion Index

- In 2021, the RBI developed the Financial Inclusion (FI) Index as a comprehensive tool to measure the extent of financial inclusion. The FI-Index integrates information from various sectors, including banking, investments, insurance, postal services, and pensions. It provides a holistic assessment of financial inclusion, assigning a single value ranging from 0 to 100, where 0 represents complete financial exclusion and 100 signifies complete financial inclusion.

#### Parameters and Dimensions of the FI-Index

- The FI-Index comprises three broad parameters with different weightage: Access (35%), Usage (45%), and Quality (20%). Each parameter includes various dimensions that are computed using a range of indicators. By evaluating these dimensions, policymakers can gain insights into the effectiveness of financial inclusion efforts and identify areas that require further attention.

#### Enhancing Financial Inclusion Policies

- The launch of the 'Antardrishti' dashboard is another significant step by the Reserve Bank of India to promote financial inclusion. It reinforces the RBI's commitment to implementing policy initiatives that support financial inclusion. By leveraging the insights provided by the dashboard, policymakers can make informed decisions to enhance financial inclusion measures and bridge the gap between the underserved and mainstream financial systems.

## Software-as-a-Service

### Why in News

Indian SaaS industry will reach \$26 billion in revenues by 2026 as per a report

#### Important Points

- The Indian Software-as-a-Service (SaaS) industry is poised to grow by 2.5X to reach a revenue of \$26 billion by the end of 2026 despite a current slowdown due to tight macroeconomic pressure and a stiff funding winter.
- Though concerns of a recession loom large, the Indian SaaS industry has displayed remarkable antifragility to withstand turbulent times.
- An overwhelming 93 percent of the founders surveyed, anticipate an increase in revenues in the next 12 months.
- Indian SaaS companies are doubling down on growth (revenue generation) while ensuring operational and capital efficiency, the report said.
- Indian SaaS equity funding rose by 30 percent to \$419 million in 2022 with 2,780 deals as against 2,605 deals in 2021 with a total funding of \$319 million.
- Despite a widely acknowledged funding winter in the Indian start-up ecosystem, seed-stage funding

witnessed a 1.5X increase, while early-stage funding experienced a notable 1.6X surge in value during 2022, the report said.

- In fact, Indian SaaS start-ups secured 3X more funding in 2022 compared to 2019, demonstrating a steady CAGR of 47 percent.



### Challenges for SaaS

- The report said that delayed sales cycles is a key challenge for founders as customers spending caution increases as they aim to optimise cloud costs.
- There is a risk of decreased customer demand in 2023 due to a recession-like situation which may reduce gross margins.
- The Indian SaaS ecosystem has exemplified remarkable adaptability and resilience in the face of recessions and external disruptions.
- This 'herd immunity' indicates that Indian SaaS companies are not just equipped to survive in challenging times but are poised to adapt, evolve, and emerge stronger.

### Outlook for 2023

- The SaaS report said that both founders and investors are optimistic about valuation multiples bouncing back to pre-pandemic levels in the next 12-18 months.
- Investors are being more prudent with their investment decisions and have directed their focus towards investing in entities that exhibit efficiency and profitability in addition to growth, the report said.
- Investors also expect an upsurge in both deal activity and exits over the next 12 months due to sustained interest in the space.
- The India advantage also extends to key opportunity areas – DevOps, Cybersecurity, and Vertical SaaS – which will lead the next phase of growth and innovation across SaaS categories, the report said.

## Crude Steel

### Why in News

India has emerged as the 2nd Largest Producer of Crude Steel in the world

### Important Points

- Union Minister of Steel and Civil Aviation held a press conference on the theme 9-years of Government's "Seva, Sushasan and Gareeb kalyan" focusing on the Steel sector, at Rajiv Gandhi Bhawan, New Delhi.
- The Minister started his address by highlighting the importance of Steel sector in ensuring the pragati (growth) and vikas (development) of the country.
- India currently ranks as the World's 2nd Largest Producer of Crude Steel, surpassing Japan in 2018.
- Highlighting achievements of the government in the last 9 years, minister mentioned that India stands as a net exporter of steel witnessing an export of 6.72 MT of finished steel against the import of 6.02 MT in 2022-23.
- The country was a net importer of steel in 2014-15 with 9.32 MT imports Vis-à-vis the export of 5.59 MT.



### Steel Scrap Recycling Policy

- Union Minister, while laying a special emphasis on the Steel Scrap Recycling Policy for promoting the scientific processing and recycling of ferrous scrap, said that Six Vehicle Scrapping Centres have been opened in various cities, with three more planning to begin their operations soon.
- The minister also mentioned that End-of-life vehicles (ELVs), will be used as raw material for the production of steel and in this regard state governments as well as private sector are being on-boarded.

### National Steel Policy 2017 (NSP 2017)

- With a focus on developing a technologically advanced and globally competitive steel industry that promotes economic growth. Government highlighted the targets set by NSP 2017, which will take the steel sector to new heights.
- Government mentioned that India has set the targets of achieving the total crude steel capacity of 300 MTPA and total crude steel demand/production of 255 MTPA by 2030-31.
- By 2030-31, it is also envisaged to enhance the operational capacity of crude steel production of SAIL from existing 19.51 MTPA to around 35.65 MTPA tentatively.
- The Government also highlighted the impact of Policy for providing preference to Domestically Manufactured Iron and Steel Products (DMI & SP Policy) in government procurement which has so far resulted in import substitution of Rs 34,800 Crore approximately.

### Productivity Linked Incentive Scheme (PLI)

- The minister, while mentioning the importance of PLI Scheme for domestic production of specialty steel said that so far 57 MoUs involving 27 companies have been signed under the scheme.
- This will attract a committed investment of around Rs 30,000 crore with a downstream capacity addition of 24.7 million tonne and an employment generation potential of 55000.
- 'Brand India' labeling is an important exercise to differentiate Indian quality steel from the others.
- The Ministry of Steel has undertaken the initiative of Made in India branding of Steel produced in the country and major Steel Producers have already come together in this direction.
- The Ministry of Steel has also on-boarded itself on the PM Gati Shakti National Master Plan Portal and identified 22 critical infrastructure gaps and is pursuing it with the Ministry of Road Transport and Highways, Ministry of Railways, Ministry of Ports, Shipping and Waterways.

### Decarbonization in steel sector

- In order to promote Decarbonization in steel sector, the Minister mentioned that the ministry has already constituted 13 task forces for identifying the action points for each aspect of green steel production and is in continuous talks with stakeholders from the steel industry and other Ministries/ Departments such as Ministry of Environment, Forests & Climate Change (MOEFCC), Railways, Power, etc.

## DLG

### Why in news

RBI releases guidelines on default loss guarantee (DLG) in digital lending

### Important Points

- The Reserve Bank came out with guidelines on default loss guarantee (DLG) in digital lending, a move aimed at ensuring the orderly development of the credit delivery system.

### What is default loss guarantee?

- DLG is a contractual arrangement between a regulated entity (RE) and an entity meeting prescribed norms, under which the latter guarantees to compensate the RE, loss due to default up to a certain percentage of the loan portfolio specified upfront.
- RE refers to entities, like banks and NBFCs, which are regulated by the RBI.

### Eligibility:

- As per the guidelines, a RE may enter into DLG arrangements only with a Lending Service Provider (LSP)/ other RE with which it has entered into an outsourcing (LSP) arrangement.
- LSP providing DLG must be incorporated under Companies Act, 2013.

### Forms of DLG:

- Cash deposited with RE.
- Fixed Deposits maintained with a Scheduled Commercial Bank in favour of RE.

- Bank Guarantee in favour of RE

**Cap:**

- DLG cover shall not exceed 5% of the amount of that loan portfolio.

**Time:**

- Maximum overdue for 120 days

**Backup**

- As per the report DLG arrangements must be backed by an explicit legally enforceable contract between the RE and the DLG provider.

**Other Provisions**

- Last year, the Reserve Bank issued the regulatory framework for digital lending.
- With a view to further promoting responsible innovation and prudent risk management, it has been decided to issue guidelines on Default Loss Guarantee arrangements in Digital Lending.
- The guidelines further said RE should ensure that the total amount of DLG cover on any outstanding portfolio, which is specified upfront should not exceed 5 per cent of the amount of that loan portfolio.
- In case of implicit guarantee arrangements, the DLG provider shall not bear performance risk of more than the equivalent amount of five per cent of the underlying loan portfolio.
- Recognition of individual loan assets in the portfolio as NPA and consequent provisioning will be the responsibility of the RE.
- Also, the REs will have put in place a Board approved policy before entering into any DLG arrangement.

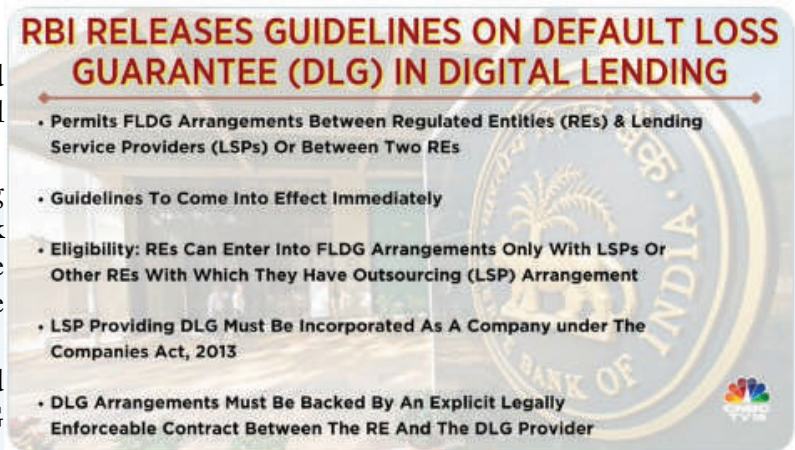
**Execution-only platform (EOP)****Why in News**

Recently, the Securities and Exchange Board of India (SEBI) issued a circular, creating a new category of intermediaries called execution-only platforms (EOPs).

**Important Points**

- It is a digital or online platform which facilitates transactions such as subscription, redemption and switch transactions in direct plans of schemes of mutual funds.
- Till now, there was no specific framework available for technology/digital platforms (including platforms provided by Investment Advisers/Stock Brokers to non-clients) to provide execution-only services in direct plans of mutual fund schemes.
- As per the new SEBI's new guidelines, no entity would be allowed to operate as an EOP without obtaining registration from SEBI or the Association of Mutual Funds in India (AMFI).

**Categories of EOP: The capital markets regulator has divided EOPs into two categories.**

- Category 1 EOPs: These would need to be registered with AMFI, the mutual fund industry body.
- Under this category, the EOPs would act as an agent of asset management companies (AMCs) and integrate their systems with AMCs and/or Registrar and Transfer Agents (RTAs) authorized by AMCs to facilitate transactions in mutual funds.
- These entities may act as an aggregator of the transactions in direct plans of schemes of mutual funds and provide services to investors or other intermediaries.
- Category 2 EOPs: These would need to be registered as a stock broker with SEBI and can operate as an agent of investors and operate only through the platforms provided by the stock exchanges

**Mutual Fund**

- It is a pool of money managed by a professional Fund Manager.
- It is a trust that collects money from a number of investors who share a common investment objective and invests the same in equities, bonds, money market instruments and/or other securities.

## South African Customs Union (SACU)

### Why in News

Amid declining merchandise exports due to demand slowdown in the West, India is placing a renewed focus on striking a trade deal with the South African Customs Union (SACU).

### Important Points

- India is placing renewed focus on striking a trade deal with a union of five countries of Southern Africa that could give a leg up to exports of pharmaceutical products and automobiles.
- According to the ministry of commerce, five rounds of negotiations regarding a potential India-SACU preferential trade agreement have been held thus far.
- The first round of discussions took place in 2007 and talks stalled in 2010.
- However, reports indicated that both sides had agreed to revive the talks in 2020.
- This comes as trade experts have pointed out that diversification of exports is crucial as 40% of India's export orders come from just seven countries and hence are more susceptible to external shocks.
- Currently, US and Europe form nearly one-third of India's merchandise exports and have driven outbound shipments in the last decade.
- Indian exports declined for the fourth consecutive month.
- Goods exports slipped 10.30% to \$34.98 billion in May 2023 compared to \$39 billion in May 2022, imports declined by 6.57% to \$57.1 billion in May 2023 compared to \$61.12 billion in the same month last year, driving the trade deficit to \$22.12 billion, the highest in over five months.
- Overall exports are on the decline as global demand slowdown has pushed international crude prices sharply lower and petroleum exports were largely driving petroleum exports during FY23.
- On a sequential basis petroleum products exports registered a sharp 23% decline in April compared to the previous month.
- Notably, a World Bank report pointed out that the growth in South Africa decelerated sharply in early 2023, reflecting policy tightening and the impact of an intensifying energy crisis.
- The country's power utility, Eskom, beset by chronic unprofitability and lack of maintenance, has been struggling to meet a post-pandemic rebound in electricity demand.



### About the South African Customs Union (SACU)

- It is the world's oldest customs union which was established in 1910.
- Member countries: South Africa, Namibia, Botswana, Lesotho, and Eswatini (formerly Swaziland).
- Head Quarter: Windhoek (Namibia)
- It was administered by South Africa through the 1910 and 1969 Agreements.
- The customs union collected duties on local production and customs duties on members' imports from outside SACU, and the resulting revenue was allocated to member countries in quarterly instalments utilising a revenue-sharing formula.
- Negotiations to reform the 1969 Agreement started in 1994, and a new agreement was signed in 2002. The new arrangement was ratified by SACU Heads of State.
- The Economic structure of the Union links the Member states by a single tariff and no customs duties between them.
- The Member States form a single customs territory in which tariffs and other barriers are eliminated on substantially all the trade between the Member States for products originating in these countries, and there is a common external tariff that applies to nonmembers of SACU.

## Liberalised Remittances Scheme

### Why in News

Twenty per cent tax on Liberalised Remittances Scheme (LRS) of the Reserve Bank of India is set to kick off soon.

### Important Points

- Banks were finding the going tough in assessing and collecting TCS on exemptions while using credit and debit cards outside India.



- The Reserve Bank of India (RBI), on the other hand, has left it to the banks to fend for themselves to collect the tax imposed by the government in the FY23-24 budget.
- LRS allows Indian residents to freely remit up to USD \$250,000 per financial year for current or capital account transactions or a combination of both. Any remittance exceeding this limit requires prior permission from the RBI.
- The scheme was introduced by RBI on February 4, 2004.
- Only individual Indian residents, including minors, are permitted to remit funds under LRS.
- Corporates, partnership firms, HUF, trusts, etc., are excluded from its ambit.
- The Union Budget 2023 introduced a Tax Collection at Source (TCS) for outward foreign remittance under LRS (other than for Education and medical purpose) of 20% on the entire value.
- Tax liability on profit made: If any profit is made on foreign investments made under LRS, it is taxable in India based on how long the investment was held.

### OUTWARD REMITTANCES UNDER THE LRS



Source: RBI

### HOW IT WORKS OUT

■ For the purpose of education, if the amount being remitted is from a loan obtained from any specified institution as defined in Section 80E: 0.5% of the amount or the aggregate amount over Rs 7 lakh per financial year

■ For the purpose of education, other than education loan or for the purpose of medical treatment: 5% of the amount or the aggregate amount over Rs 7 lakh per financial year

#### Overseas tour packages

**20%** TCS without any threshold limit

#### Any other purpose under LRS

**20%** without any threshold limit

■ Resident individual falling under "Specified Person" category/ non-PAN case/ inoperative PAN case: Double the normal rate of TCS or 5%, whichever is higher. However, TCS rate shall not exceed 20%

### Frequency of Remittances:

- There are no restrictions on the frequency of remittances under LRS.
- Once a remittance is made for an amount up to USD 2,50,000 during the financial year, a resident individual would not be eligible to make any further remittances under this scheme.

### Types of transactions permitted:

- Opening of foreign currency accounts abroad with a bank;
- Acquisition of immovable property abroad, overseas direct investment (ODI), and overseas portfolio investment (OPI);
- Extending loans, including loans in Indian Rupees to non-resident Indians (NRIs) who are relatives as defined in the Companies Act, 2013;
- Private visits abroad(excluding Nepal and Bhutan);
- Maintenance of relatives abroad;
- Medical treatment abroad;
- Pursuing studies abroad.

## Neuralink Chip

### Why in News

Elon Musk's brain implant company is approved for human testing.

### Important Points

- Elon Musk's brain-implant company Neuralink received regulatory approval to conduct the first clinical trial of its experimental device in humans.
- But the billionaire executive's bombastic promotion of the technology, his leadership record at other companies and animal welfare concerns relating to Neuralink experiments have raised alarm.
- Neuralink is far from the first or only company working on brain interface devices.
- For decades, research teams around the world have been exploring the use of implants and devices to treat conditions such as paralysis and depression.
- Already, thousands use neuroprosthetics like cochlear implants for hearing. But the broad scope of capabilities Musk is promising from the Neuralink device have garnered skepticism from experts.
- Neuralink was founded quietly in 2016 and flew mostly under the radar until showcasing its technology in 2019.
- It is building a device that can directly interface with the human brain—called the “Link,” a sort of brain chip Musk has described as a “Fitbit in your skull”—and a robot that can automatically implant it like a kind of neural sewing machine.
- Its device makes use of “ultra-flexible, tiny electrodes implanted directly into the brain tissue to ‘listen’ to the communication between neurons.
- Neuralink is not the only company doing this or even the most advanced—brain implants for conditions like Parkinson's disease are already in widespread use and similar firms like Blackrock Neurotech and Synchron have already started human tests, the former decades ago—but receives more media attention because it is well-funded and has a connection to Musk rather than having a novel or technically astounding device.
- By allowing the human brain to directly interface with computers and other devices, neurotech companies hope they can help people regain abilities lost through things like injury or disease, for example a camera could be used to stimulate areas of the brain associated with vision to restore sight or a robot limb could be connected to an area of the brain that controls movement.
- Device connects the brain to an external computer via a Bluetooth signal, enabling continuous communication back and forth.
- It could enable precise control of prosthetic limbs, mimicking natural motor functions and revolutionize treatments for conditions such as parkinson's, epilepsy, spinal cord injuries, autism, depression etc.
- So far, Neuralink has tested its chips on animals. A video released in 2021 shows a monkey using the device to play the video game Pong with his mind and another from 2022 appeared to show a monkey typing on a computer telepathically.



## United Nations New Policy

### Why in News

For all humanity —the future of outer space governance policy brief released by united nation

### Important Points

- The United Nations (UN) has recently released a policy brief titled “For All Humanity — The Future of Outer Space Governance,” recommending the development of a new treaty to ensure peace, security, and the prevention of an arms race in outer space.
- The recommendations come ahead of the upcoming UN Summit of the Future, scheduled for September 2024, in New York.
- The summit aims to facilitate multilateral solutions and strengthen global governance to address future challenges.

### Highlights of the Policy:

- There has been an exponential increase in satellite launches over the past decade, driven by both government and private sector participation.
- In 2013, there were 210 new launches, which increased to 600 in 2019 and 1,200 in 2020 and 2,470 in 2022.
- Countries like the United States, China, India, and Japan are leading the way in space activities, including manned missions, lunar exploration, and resource exploitation.
- National Aeronautics and Space Administration (NASA), through its Artemis mission, plans to land the first woman and the next man on the Moon.
- Minerals on the Moon (has rich deposits of helium 3, which is rare on Earth), asteroids (abundant deposits of valuable metals, including platinum, nickel and cobalt) and planets can be attractive for countries.
- There is an absence of an agreed international framework on space resource exploration, exploitation, and utilization.
- The brief underscores the importance of establishing mechanisms to support the implementation of space resource activities while addressing issues of jurisdiction, control, liability, and responsibility for environmental pollution.
- The current coordination of space traffic is fragmented, with different national and regional entities employing varying standards and practices.
- The lack of coordination poses challenges for countries with limited space capacity.
- The proliferation of space debris is identified as a significant issue, with thousands of objects posing threats to operational spacecraft.
- The UN calls for legal considerations related to jurisdiction, control, liability, and responsibility for environmental pollution caused by space debris. Technology to remove space junk is being developed, but the legal aspects require attention.

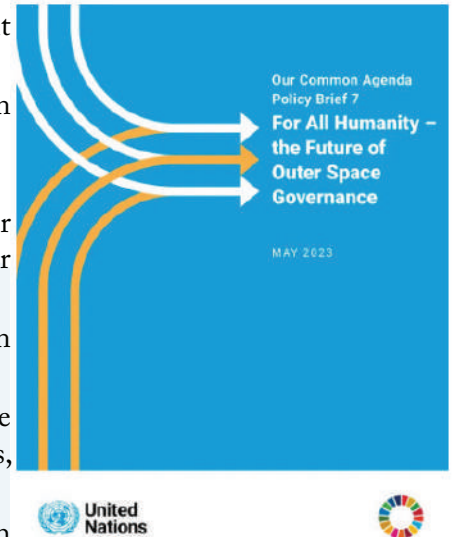

### Recommendations:

- The UN recommends the negotiation and development of a new treaty to ensure peace, security, and the prevention of an arms race in outer space.
- This treaty would establish international norms, rules, and principles to address emerging threats and promote responsible space activities.
- Member states are urged to establish an effective framework for coordinating space situational awareness, space object maneuvers, and space events. This coordination will enhance the safety and security of space operations.
- The UN calls for the development of norms and principles for Space Debris removal, considering both legal and scientific aspects.
- An effective framework for sustainable exploration, exploitation, and utilization of space resources, particularly on the Moon and other celestial bodies, is recommended.



## Stars to become invisible

### Why in News

Scientists warn stars, constellations could be invisible within 20 years

### Important Points

- Scientists have warned that the ability of humans to see the cosmos in the night sky may vanish in just 20 years because of light pollution.
- The night sky is part of our environment and it would be a major deprivation if the next generation never got to see it, just as it would be if they never saw a bird's nest.
- In the last few years, the issue of light pollution has rapidly worsened, especially since 2016 when it was reported by astronomers that the Milky Way is no longer visible to almost a third of the population, as per Rees.
- Scientists stated that the increasing light pollution is now brightening up the night sky at a rate of around 10 per cent per year.

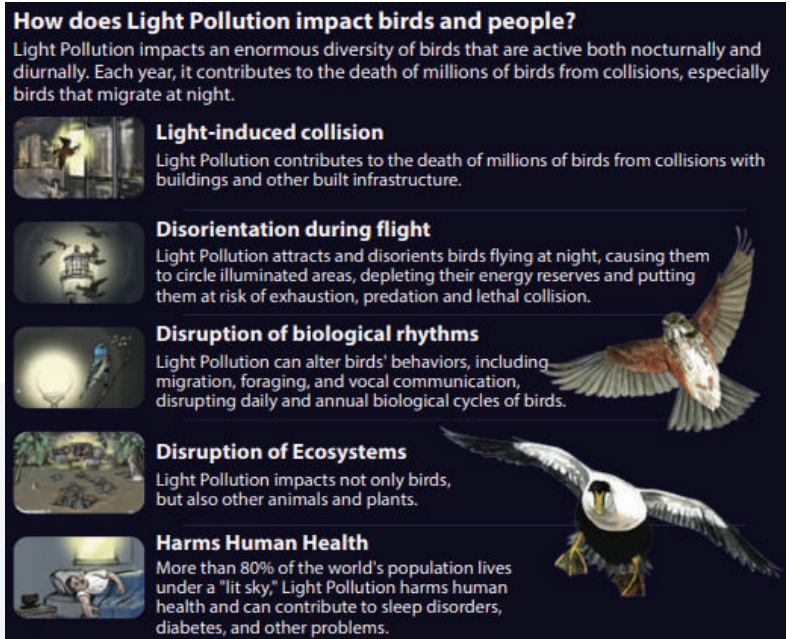

### No cosmos for future generations

- A child who is born in a place where 250 stars are currently visible in the night sky would be able to see only 100 by the time they reach the age of 18, stated the German Centre for Geosciences.
- A couple of generations ago, people would have been confronted regularly with this glittering vision of the cosmos – but what was formerly universal is now extremely rare.
- Only the world's richest people, and some of the poorest, experience that anymore. For everybody else, it's more or less gone.

### What is Light Pollution?

- The inappropriate or excessive use of artificial light – known as light pollution – can have serious environmental consequences for humans, wildlife, and our climate.

### Components of light pollution include:

- Glare – Excessive brightness that causes visual discomfort
- Skyglow – Brightening of the night sky over inhabited areas
- Light trespass – Light falling where it is not intended or needed
- Clutter – Bright, confusing and excessive groupings of light sources

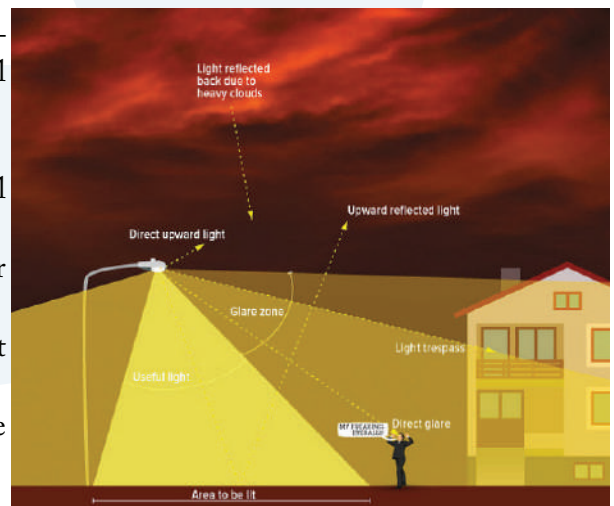

### How Bad is Light Pollution?

- According to the 2016 groundbreaking “World Atlas of Artificial Night Sky Brightness,” 80 percent of the world's population lives under skyglow. In the United States and Europe 99 percent of the public can't experience a natural night.

### Causes of Light Pollution

1. Poor Planning: The placement of signage and street lights is planned by engineers, and if they do not take into account the effect placement has on the surrounding environment, they can create glare, light trespass and light clutter.
2. Irresponsible Use: Leaving a room with the lights still on or setting the timers on streetlamps and not adjusting the timer for the season. Not actively choosing to minimize energy waste is a huge source of light pollution.

3. Overpopulation: That is really a zoning issue. Too many businesses or too many residences, grouped in one area can cause light pollution of many kinds.
4. Excessive Use of Light: One significant cause of light pollution is the excessive use of electric light. Electricity has become quite cheap over time; therefore, people do not care too much about their electricity consumption. This leads to an over-consumption of electricity and also in excessive use of light, especially at night time.
5. Smog and Clouds: Smog and clouds can reflect the light emitted by cities and thus make the surrounding environment look much brighter, causing light pollution.

## Brain Electrical Oscillation Signature Profiling (BEOS)

### Why in News

BEOS is a technique by which a suspect participation in a crime is detected by electing electro physiological impulses.

### Important Points

- It is a tool which measures the changes in electrical activity of the brain associated with the presence of knowledge provoked by probe when the suspect does not have to offer an answer or response.
- It works on EEG (Electroencephalograph machine).
- BEOS is a non-invasive technique with a great degree of sensitivity and a neuropsychological method of interrogation which is referred to as brain fingerprinting or brain finger mapping.
- BEOS is used to identify individuals with experience of participating in a crime.
- BEOS was developed by Champadi Raman Mukundan, a neuroscientist, former professor and head of clinical psychology at National Institute of Mental Health and Neurosciences, Bangalore India.
- He had some data on the links between the brain and memory and he translated it into 11 set of psychological variables. If all 11 variables come up positive on an EEG then the statement being read out to the suspect was assumed to be true.



### Components:

**Knowing and remembering are two neuro cognitive process.**

- i. Knowing: It refers to cognitive process of recognition with or without familiarity.
- ii. Remembering: It is the recall of episode and autobiographical details from a person's life.

### Procedure:

1. Pre-test interview with the suspect in BEOS.
2. The suspect is acquainted with BEOS test procedure.
3. Informed consent is obtained.
4. No questions are to be asked while conducting test rather the subject is simply provided with events/ scenario and the results are analysed to verify if the brain produces any experiential knowledge and it should be disclosed.

### Operating Mechanism:

1. A picture/ word is shown to an individual.
2. If it is known or familiar then it will trigger neuron of brain.
3. Triggering of neurons will generate brainwave (P 300).
4. Due to generation of brainwaves electrical potential is accumulated in brain.
5. A mead gear is fitted with electrodes placed on scalp of the individual.
6. The scalp ERG EEG measures brainwaves.
7. The measurement of brainwaves generates analog signals which are amplified in an EEG amplifier.
8. The analog signals that are amplified are studied using computer program to determine if the individual is guilty/ not guilty.

**How brainwaves are used to detect guilty:**

- If it is red person is guilty.
- If it is green person is not guilty.
- If it is blue then the information is such that the person might know but is not familiar with it.

**Probes used in BEOS:**

- Probes are used to stimulate the brain of a person for the purpose of finding facts and it induce responses which can be linked to the content of probe.

**Two types of probes are used in BEOS:**

- Auditory probes
- Visual probes

**Essential conditions for successful BEOS examination:****Consent:**

- The subject has the right to refuse to take the test.
- There must be written consent if the test is taken voluntarily.
- No consent is required in cases where BEOS is carried out on court orders.

**BEOS system:**

- Video integrated EEG
- High quality non-polarizing electrode
- Computer software

**Examiner:**

- He must have Ph.D. in Psychology.

**Examinee:**

- He should be under good physical and mental condition.
- He should not suffer from any physical or mental diseases.
- He should not be under the influence of drugs or alcohol.

**BEOS examination room:**

- Room should be electrical proof.
- It must be air-conditioned.
- There should be one side mirror in the room.
- There must be CCTV and recording system in the room.

**Privacy:**

- Only the examiner and examinee must be present in the room where BEOS is conducted.

**Objectives of BEOS:**

- To identify the offender.
- To exonerate innocent person.
- To differentiate the actual perpetrator of the crime

**Advantages of BEOS:**

- It is non-invasive technique.
- It saves time.
- No interaction with the subject.
- No response is required from the subject.

**Position in India:**

- On May 5, 2010 the Supreme Court Judge Balasubramaniam in the case “Smt. Selvi vs. State of Karnataka” held that narcoanalysis, polygraph and brain mapping tests were to be allowed after consent of accused.

**The judge stated:**

- We are of the considered opinion that no individual can be forced and subjected to such techniques involuntarily, and by doing so it amounts to unwarranted intrusion of personal liberty.



## Antimicrobial Resistance (AMR)

### Why in News

European Commission adopted a proposal of actions to combat Antimicrobial Resistance (AMR) in One Health approach.

### Important Points

- The Council of the European Union (EU) adopted a set of recommendations to strengthen action against antimicrobial resistance (AMR).
- It recommended prudent use of antimicrobials such as antibiotics in human and animal health for reducing the risk of microorganisms becoming resistant to medical intervention.
- These recommendations were part of a proposal submitted by the European Commission to the European Council on April 2023.
- The commission submitted the proposal for a recommendation on stepping up EU actions to combat AMR in a One Health approach.
- The approach was adopted because the health of humans, animals and the environment is intrinsically linked.
- AMR can only be overcome through joint efforts across all three areas.
- The proposal was part of a package of measures aimed at reforming the EU's pharmaceutical legislation.
- It is estimated that more than 35,000 people die each year in the EU / European Economic Area as a direct consequence of an infection due to bacteria resistant to antibiotics.
- Antimicrobial resistance is the ability of bacteria and other microbes to resist the drugs used to inhibit or kill them. Resistant microbes can pass between animals, plants and food and in the environment.
- This phenomenon has many health and economic implications, with an estimated 4.95 million deaths associated with bacterial AMR in 2019.

### The proposal included a series of actions to:

- strengthen national action plans against antimicrobial resistance
- reinforce surveillance and monitoring of AMR and antimicrobial consumption (AMC)
- strengthen infection prevention and control as well as antimicrobial stewardship and prudent use of antimicrobials
- recommend targets for AMC and AMR in human health
- improve awareness, education and training
- foster research and development, incentives for innovation and access to antimicrobials and other AMR medical countermeasures
- increase cooperation
- enhance global actions
- Several targets for EU member states, developed with the European Centre for Disease Prevention and Control, were set for 2030.
- The targets called for closing existing surveillance and monitoring gaps and ensuring the completeness of data, including real-time information.

### WHAT'S AMR?

Resistance of a micro-organism to an antibiotic that was originally effective in treating infections caused by it

### Why India needs to curb antibiotic overuse

- India's bacterial disease burden is highest in the world
- Large population suffers from diseases like diabetes, heart ailments and cancer, making them prone to infections
- 40% children are malnourished and at risk of infections
- More and more drug-resistant bacteria are being identified



### OLDER, ICU PATIENTS MORE VULNERABLE

➤ Antimicrobial resistance happens when microorganisms (such as bacteria, fungi, viruses, and parasites) change after exposure to antimicrobial drugs (such as antibiotics, antifungals, antivirals, antimalarials, and anthelmintics)

➤ Microorganisms that develop antimicrobial resistance are sometimes referred to as 'superbugs'

➤ As a result, medicines become ineffective and infections persist in the body, increasing the risk of spread to others

➤ New resistance mechanisms are emerging and spreading globally, threatening our ability to treat common infectious diseases, resulting in prolonged illness, disability, and death

➤ Without effective antimicrobials/antibiotics for prevention and treatment of infections, medical procedures such as organ transplantation, cancer chemotherapy, diabetes management and major surgery (for example, caesarean sections or hip replacements) become very high risk



### THIS STUDY

➤ 5,103 antibiotic sensitivity tests of 4,437

patients taken from 10 hospitals of Fortis group across country

➤ Analysis showed patients with resistant bacteria had 2-3 times the risk of death as compared to those with bacteria that were sensitive to drugs

➤ Patients had resistance to multiple drugs for strains of microbes such as E. coli, K pneumoniae, and A baumannii

➤ Mortality due to methicillin-resistant S aureus (MRSA) was significantly higher than susceptible strains

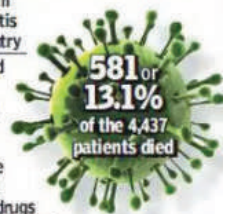

- It also includes timely access to data on both AMR and AMC at all levels, like the community, hospitals and long-term care facilities.
- Reducing the total consumption of antibiotics in humans by 20 per cent in the Union compared with the baseline year of 2019 is also another target.
- This would be applicable for the community and hospital sectors combined, including in long-term care facilities and in home-care settings.
- The member states must also ensure that at least 65 per cent of the total consumption of antibiotics in humans belongs to the access group of antibiotics as defined in the AWaRe classification of the World Health Organization.
- By 2030, total incidents of bloodstream infections per 100,000 population by methicillin-resistant *Staphylococcus aureus* needs to be reduced by 15 per cent compared to 2019.
- Infections by third generation cephalosporin-resistant *Escherichia coli* must be decreased by 10 per cent through 2030 and carbapenem-resistant *Klebsiella pneumoniae* should go down by 5 per cent.
- The zero pollution vision for 2050 by the Union is for air, water and soil pollution to be reduced to levels no longer considered harmful to health and natural ecosystem.
- Within infection prevention and control, the AMR recommendations are along the lines of fully developing and implementing national immunisation programmes and taking measures to effectively prevent vaccine-preventable diseases.
- The recommendations for increasing awareness about AMR focus on promoting knowledge and behavioural change by providing professionals working in the human health, veterinary and agronomy sectors with regularly updated information about AMR at national and local levels.

## Mobile Satellite Service (MSS) terminals

### Why in News

ISRO to set up satellite terminals on fishing boats in 13 coastal states

### Important Points

- NewSpace India Ltd, the commercial arm of the Indian Space Research Organisation (ISRO), is installing mobile satellite service (MSS) terminals on at least 1 lakh motorized and fishing boats across 13 coastal states to improve communication with seagoing vessels and more effectively monitor Indian waters.
- NewSpace India has begun choosing private vendors to provide, install, and commission MSS terminals for setting up vessel communication and support systems in marine fishing vessels for monitoring, control, and surveillance.
- The overall scope of work of the project includes the establishment of a dedicated MSS satcom network for supporting emergency communication and tracking of maritime assets Xponders.
- This includes the establishment of a dedicated 9m/11m C-band ground station and hub baseband system, arranging for satellite bandwidth and guiding required service approvals, and building satellite terminals for field deployment across nine coastal states and four union territories.
- The system would run on NavIC (Navigation with Indian Constellation), which was released by ISRO and is owned and operated by India.
- The network would include specialized ground stations and satellite terminals for field deployment to increase national security and provide improved protection for fishermen in Indian waters.
- These Xponders will be installed in the coastal states of Andhra Pradesh, Gujarat, the Andaman and Nicobar Islands, Goa, Karnataka, Kerala, Odisha, Maharashtra, Daman and Diu, Puducherry, Tamil Nadu, Lakshadweep, and West Bengal.

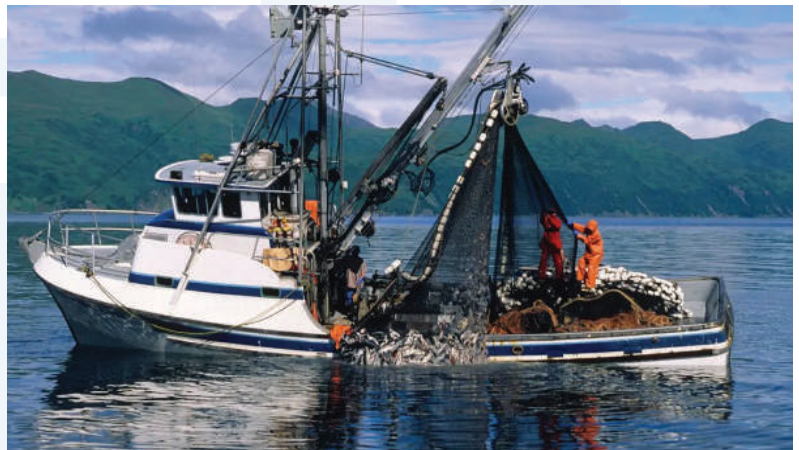



- According to officials, once the network is in place, authorities will be able to establish a two-way communication system with fishermen, periodically access positions, send out emergency weather alerts, alert people when an international maritime border is being crossed, and send out precise navigation alerts.
- All Xponders will have in-built wifi and Bluetooth transceivers to communicate. A multilingual app is also being developed to allow communication between the app and transponders.
- Advantages: Establish better communication with vessels in sea; Better security to fishermen; Monitor Indian waters more efficiently and improve national security.

## Solar Ultraviolet Imaging Telescope (SUIT)

### Why in News

Pune's IUCAA team develops space telescope to capture ultraviolet imaging of Sun

### Important Points

- The Solar Ultraviolet Imaging Telescope (SUIT), a unique space telescope developed by Pune's Inter-University Center for Astronomy and Astrophysics (IUCAA), is now ready and has been delivered to the Indian Space Research Organisation (ISRO).
- The telescope is set to be integrated with the ADITYA-L1 mission, expected to be launched in mid-August this year.

### ADITYA-L1 mission

- ADITYA-L1 will be ISRO's first space observatory dedicated to studying the Sun.
- It will fly approximately 1.5 million kilometers from Earth to the L1, or Lagrange point 1, which is one of the five favorable spots for observing the Sun.
- The mission aims to provide regular images and updates on the Sun's surface phenomena and space weather.
- The Aditya-L1 mission will carry seven different payloads capable of studying various phenomena on the Sun across the electromagnetic spectrum and solar wind. Aditya-L1 will enable seamless measurement of solar radiation from Hard X-ray to Infrared, as well as in-situ measurements of particles in the solar wind and the Sun's magnetic field at the L1 Point.
- After the launch of the Aditya-L1 mission, it will take approximately 100 days to reach the halo orbit around the L1 point, where all seven unique payloads will carry out scientific observations.
- In addition to the initial grant of Rs 25 crore from ISRO for the hardware, scientists faced several challenges during the development of the payload, including building an ultra-clean room and designing special filters to capture the radiation.

### Configuration of SUIT

- SUIT has an off-axis Ritchey-Chrétien configuration with a combination of 11 narrow and broad bandpass filters which will be used for full-disk solar imaging in the Ultraviolet (UV) wavelength range 200-400 nm.
- The SUIT telescope will address fundamental questions such as the existence of a higher-temperature atmosphere above the cooler surface of the Sun and the origin and variation of near-ultraviolet radiation and high-energy solar flares.

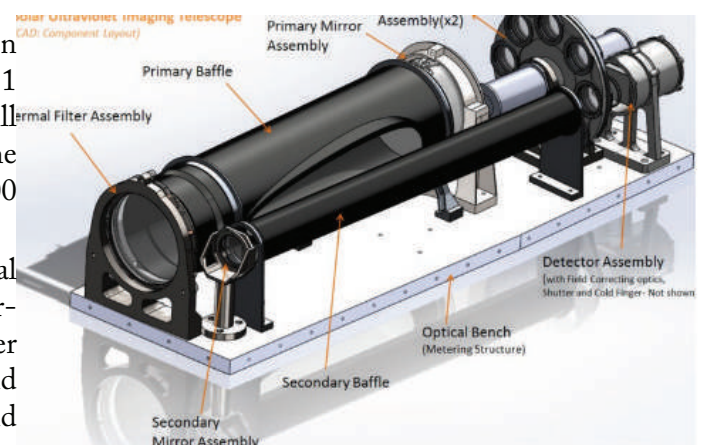
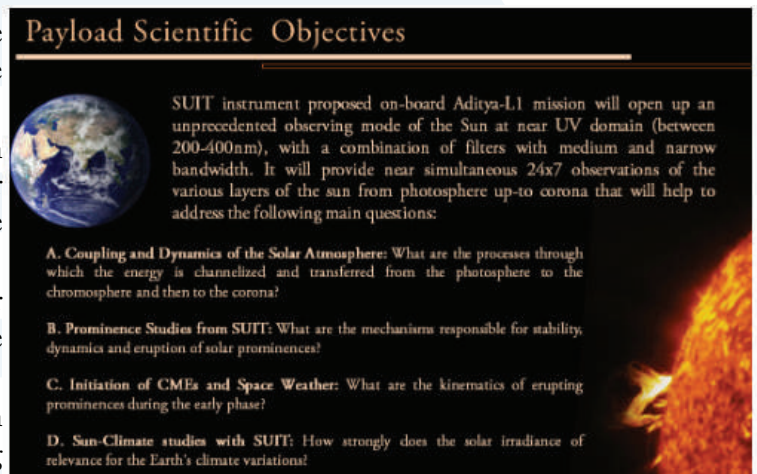



- Through SUIT, there will be seamless measurement of solar radiation from Hard X-ray to Infrared, as well as in-situ measurements of particles in the solar wind, including the Sun's magnetic field at the L1 point.
- The SUIT project involved over 200-300 scientists over the last ten years.
- SUIT, for the first time, will allow us to record images in this wavelength crucial for maintaining the Ozone and Oxygen content in the atmosphere of the Earth.
- SUIT will also measure the UV radiation hazardous for skin cancer.

## Synthetic human embryos

### Why in News

Scientists develop synthetic embryos using stem cells

### Important Points

- Scientists have created synthetic human embryos using stem cells, in a groundbreaking advance that sidesteps the need for eggs or sperm.
- These model embryos, which resemble those in the earliest stages of human development, could provide a crucial window on the impact of genetic disorders and the biological causes of recurrent miscarriage.
- However, the work also raises serious ethical and legal issues as the lab-grown entities fall outside current legislation in the UK and most other countries.
- The structures do not have a beating heart or the beginnings of a brain, but include cells that would typically go on to form the placenta, yolk sac and the embryo itself.
- There is no near-term prospect of the synthetic embryos being used clinically.
- It would be illegal to implant them into a patient's womb, and it is not yet clear whether these structures have the potential to continue maturing beyond the earliest stages of development.
- The motivation for the work is for scientists to understand the "black box" period of development that is so called because scientists are only allowed to cultivate embryos in the lab up to a legal limit of 14 days.
- They then pick up the course of development much further along by looking at pregnancy scans and embryos donated for research.

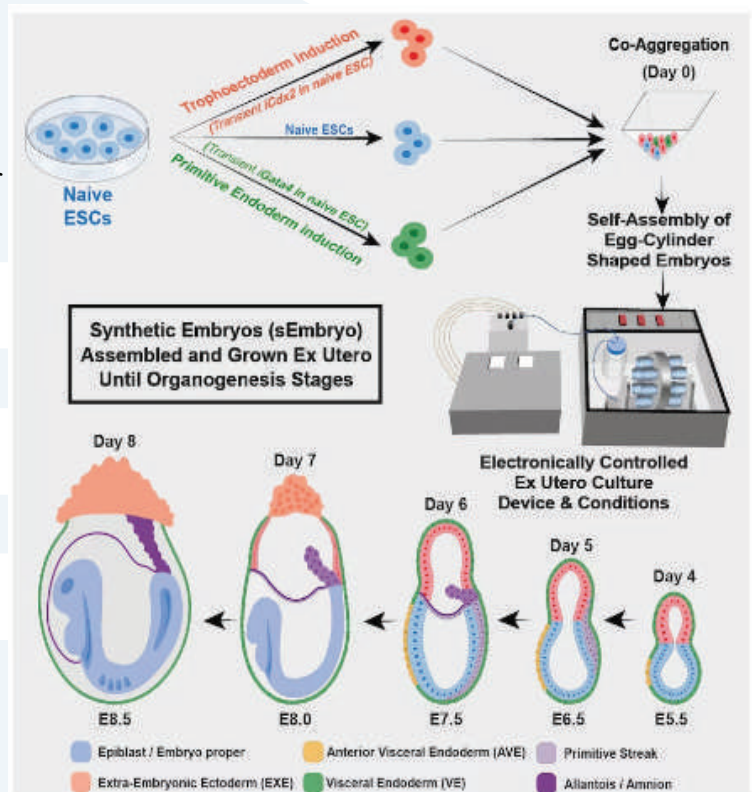

### Importance:

- Will help understanding the impact of genetic disorders and the biological reasons behind recurrent miscarriages.
- Reportedly dodges the need for eggs or sperms for the creation of human embryos.

### About stem cells:

- A cell with the unique ability to develop into specialised cell types in the body.
- Provide new cells for the body as it grows, and replace specialised cells that are damaged or lost.

### Two unique properties:

- Can divide over and over again to produce new cells.
- As they divide, they can change into the other types of cell that make up the body

## Phonons

### Why in News

Physicists split phonons using quantum mechanics

### Important Points

- Scientists have successfully split phonons, demonstrating their quantum properties and ability to manipulate and control quantum states.
- Phonons are quasiparticles that represent collective vibrations of atoms or molecules in a solid material.
- Achievement may lead to development of sound-based versions of quantum computers or extremely sensitive measuring devices in future.
- Recently, IBM published a paper in which it claimed to have demonstrated that a quantum computer could solve a useful problem that today's conventional computers can't, a result merited by concerns that their computations might become too unreliable when they also become complicated.

### What is Qubits?

- Quantum computers use qubits as their basic units of information.
- A qubit can be a particle — like an electron; a collection of particles; or a quantum system engineered to behave like a particle.
- Particles can do funky things that large objects, like the semiconductors of classical computers, can't because they are guided by the rules of quantum physics.
- The premise of quantum computing is that information can be 'encoded' in some property of the particle, like an electron's spin, and then processed using these peculiar abilities.
- As a result, quantum computers are expected to perform complicated calculations that are out of reach of the best supercomputers of today.
- Other forms of quantum computing use other units of information. For example, linear optical quantum computing (LOQC) uses photons, the particles of light, as qubits.

### Phonons

- Physicists thus wondered whether they can use phonons as qubits.
- Photons are packets of light energy; similarly, phonons are packets of vibrational energy.
- While researchers can manipulate electrons using electric currents, magnetic fields, etc. and photons with mirrors, lenses, etc, they needed new tools to manipulate phonons.
- Beam-splitters are used widely in optics research. Imagine a torchlight shining light along a straight line. This is basically a stream of photons.
- When a beam-splitter is placed in the light's path, it will split the beam into two, that is, it will reflect 50% of the photons to one side and let the other 50% pass straight through.
- When the single wave interacts with the beam-splitter, it enters a superposition of the two possible outcomes — reflected and transmitted. When these states recombine, an interference pattern shows up.

### Types of Phonon

- When the unit cell consists of more than one atom, the crystal will contain two types of phonons. Thus, there are two types of phonons that we study in condensed matter physics:
- Acoustic Phonon: In acoustic phonons, both positive and negative ions swing together.
- Optical Phonon: In optical phonons, both positive and negative ions swing against each other. The optical phonons are excited easily by light.

### Properties of Phonons

- Phonons are often used as a quasi-particle, some popular research has shown that phonons and protons may indeed have some kind of mass and be affected by gravity.
- Phonons are said to have a kind of negative mass and negative gravity.
- Phonons are known to travel faster (with maximum velocity) in denser materials.
- It is projected that phonons would deflect away as it detects the difference in densities, exhibiting the qualities of a negative gravitational field.
- Phonons have also been predicted to play a key role.
- They can also be used as quasi-particles.
- They can be affected by gravity.
- They tend to have negative energy and negative mass.
- They travel faster in denser material (with higher velocity).

## Higgs boson

### Why in News

Rare Higgs boson decay observed in Large Hadron Collider experiments

#### Important Points

- The European Organization for Nuclear Research (CERN), which hosts the Large Hadron Collider, (LHC) announced that scientists at the organisation found the first evidence of the rare process by which the Higgs boson decays into a Z boson and a photon.
- The discovery of the Higgs boson, what some call the “god particle,” in 2012 marked a major milestone in the study of particle physics.
- Since that discovery, scientists working with the ATLAS and CMS experiments at LHC have been investigating the properties of the particle, trying to understand the ways in which it is produced and how it decays into other particles.
- At the Large Hadron Collider Physics (LHCP) conference last month, ATLAS and CMS teams reported how they discovered evidence of the Higgs boson decaying into a Z boson and a photon.
- The Z boson is the electrically neutral carrier of the weak force and the photon is the carrier of the electromagnetic force.

#### Standard model

- According to CERN, this decay could provide indirect evidence of the existence of particles beyond those predicted by the Standard Model of particle physics.
- The Standard Model is the current best theory that can explain all phenomena associated with elementary particles, or the building blocks of the universe.
- It contains 12 fundamental matter particles categorized as quarks (which make up protons and neutrons) and leptons (which include electrons).
- It explains how force carrying particles, which belong to a broader group of bosons, influence quarks and leptons.
- It contains three forces that govern the behavior of matter i.e., Electromagnetism, Strong force, and Weak force.
- Force of gravity is currently not included in the standard model.

#### Decay of the Higgs boson

- The Higgs boson particle’s decay into a Z boson and photon is similar to that of a decay into two photons, according to CERN.
- In these cases, the particle does not directly decay into these pairs of particles.
- Instead, it happens through, and “intermediate loop of virtual particles” that come into and out of existence but cannot be detected directly.
- These “virtual” particles could include new and so far unknown particles that interact with the Higgs boson

#### About The European Organization for Nuclear Research (CERN)

- CERN was established in 1954. It has 23 member states. 22 members are European countries. Israel is the only non-European nation that has full membership in CERN.
- India is the associate member of CERN and USA has observer status at CERN.
- CERN is located in Geneva and it is an official Observer to the United Nations (UN).

#### Functions of CERN

- Its most important function is to provide the particle accelerators and other related infrastructure required for high-energy physics research.
- CERN operates the largest particle physics laboratory in the world. Originally, the laboratory was solely used to study atomic nuclei.
- Later, it is also being used for research in higher-energy physics to study interactions between subatomic particles.

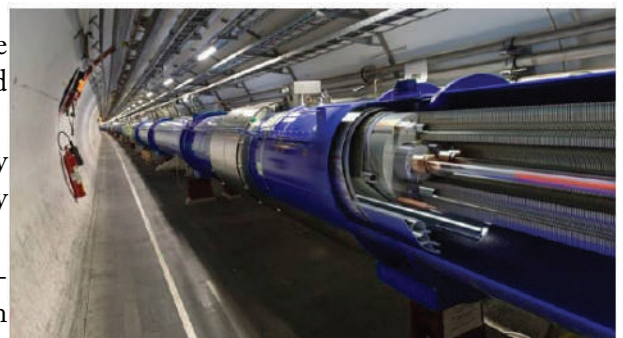



## Viruses

### Why in News

Public aware of and accept use of bacteria-killing viruses as alternative to antibiotics, study shows

### Important Points

- The public are in favour of the development of bacteria-killing viruses as an alternative to antibiotics – and more efforts to educate will make them significantly more likely to use the treatment, a new study shows.
- The antimicrobial resistance (AMR) crisis means previously treatable infections can kill.
- This has revitalised the development of antibiotic alternatives, such as phage therapy, which was first explored over a century ago but abandoned in many countries in favour of antibiotics.
- The study shows public acceptance of phage therapy is already moderately high, and priming people to think about novel medicines and antibiotic resistance significantly increases their likelihood of using it.
- There is a higher acceptance of phage therapy when described without using perceived harsh words, such as “kill” and “virus” but instead “natural bacterial predator”.
- Those who took part in the survey had a high awareness of antibiotic resistance – 92 per cent had heard of antibiotic resistance, but only 13 per cent reported that they had heard about phage therapy prior to the survey.
- Success and side effect rate, treatment duration, and where the medicine has been approved for use, influenced their treatment preferences.
- The study was conducted by Sophie McCammon, Kirils Makarovs, Susan Banducci and Vicki Gold from the University of Exeter.

### Significance of phage therapy

- Phages are unlikely to damage human cells due to significant differences in bacterial cells and human cells.
- Since they can replicate, initial dosage can be relatively small.
- Inherently nontoxic as they are made up of nucleic acids and proteins.
- Challenges in developing phage therapeutics: Lack of clinical trials, time consuming process of finding right phages, difficulties in patenting phages as they are natural entities etc.

## MAHIR

### Why in News

Mission on Advanced and High-Impact Research (MAHIR) launched to leverage Emerging Technologies in Power Sector

### Important Points

- The Ministry of Power and the Ministry of New and Renewable Energy have jointly launched a National Mission to quickly identify emerging technologies in the power sector and develop them indigenously, at scale, for deployment within and outside India.
- The National Mission, titled “Mission on Advanced and High-Impact Research (MAHIR)” aims to facilitate indigenous research, development and demonstration of the latest and emerging technologies in the power sector.
- By identifying emerging technologies and taking them to the implementation stage, the Mission seeks to leverage them as the main fuel for future economic growth and thus make India a manufacturing hub of the world.
- The Mission will be funded by pooling financial resources of the Ministry of Power, Ministry of New and Renewable Energy and the Central Public Sector Enterprises under the two Ministries.
- Any additional funding needed will be mobilized from Government of India’s budgetary resources.
- Planned for an initial period of five years from 2023-24 to 2027-28, the Mission will follow the technology life cycle approach of Idea to Product.

### Mission Objectives

The key objectives of the Mission are as follows:

- To identify emerging technologies and areas of future relevance for the Global Power Sector and take up indigenous end-to-end development of relevant technologies
- To provide a common platform for Power Sector Stakeholders for collective brainstorming, synergetic technology development and devise pathways for smooth transfer of technology

- To support pilot projects of indigenous technologies (developed especially by Indian Start-ups) and facilitate their commercialization
- To leverage foreign alliances and partnerships to accelerate research & development of advanced technologies and to build competencies, capabilities and access to advanced technologies through bilateral or multilateral collaborations, thereby facilitating exchange of knowhow and Technology Transfer.
- To seed, nurture and scale up scientific and industrial R&D and to create vibrant & innovative ecosystem in the Power Sector of the country
- To make our Nation among the leading Countries in Power System related Technologies & Applications development

### Areas Identified for Research

**To begin with, the following eight areas are identified for research:**

- Alternatives to Lithium-Ion storage batteries
- Modifying electric cookers / pans to suit Indian cooking methods
- Green hydrogen for mobility (High Efficiency Fuel Cell)
- Carbon capture
- Geo-thermal energy
- Solid state refrigeration.
- Nano technology for EV battery
- Indigenous CRGO technology

### Structure of the Mission

**The Mission will have a two-tier structure - a Technical Scoping Committee and an Apex Committee.**

- The Technical Scoping Committee, chaired by the Chairperson of Central Electricity Authority, will identify ongoing and emerging research areas globally, recommend potential technologies for development under the Mission, justify the techno-economic advantages, provide research outlines, and conduct periodic monitoring of approved research projects.
- The Technical Scoping Committee (TSC) will survey and identify the on-going and emerging areas of research globally and will make recommendations to the Apex Committee. The TSC shall identify the potential technologies that can be considered for development under the Mission.
- The TSC will bring out the relevance of the technology for the future of the Power Sector and justify the Techno-economic advantage of indigenous development of the Technology and come out with a roadmap for market creation for the Technology.
- The TSC will also provide a broad range of specifications desired from the final product. Periodic monitoring of the approved research projects will also be carried out by the TSC.
- The Apex Committee, chaired by the Union Minister for Power & New and Renewable Energy will deliberate on the technology and products to be developed and approve the research proposals. The Apex committee will look also into international collaborations.
- The Apex Committee will approve the research proposals and monitor the progress of research. The technology / product to be developed under the Mission will be deliberated by the Apex Committee. The final approval of all the research proposals / projects shall be given by the Apex Committee.

### Scope of the Mission

- Under the Mission, once research areas are identified and approved by the Apex Committee, the proposals for outcome-linked funding will be invited from companies / organizations across the globe.
- The selection of the proposal shall be done through Quality cum Cost-Based Selection (QCBS) basis. The organizations of the Ministries may also co-develop the technologies with the selected Research Agency.
- The IPR of the technology developed would be shared by the Government of India and the Research Agency.
- The Mission shall also fund pilot projects of technologies developed by Indian Start-ups and facilitate their commercialization through the Central Public Sector Enterprises under both the Ministries.
- The start-ups will have to share the IPR with the Government of India / Central Power Research Institute.
- The Mission will also facilitate international collaboration for smooth exchange of know-how and Technology Transfer. The Mission will also seek collaboration with the best laboratories of the world for joint development of technologies.

## Vaccine for respiratory syncytial virus (RSV)

### Why in News

EU approves its first vaccine for common respiratory virus RSV

### Important Points

- European regulators have approved the region's first vaccine for respiratory syncytial virus (RSV), which causes thousands of hospitalisations and deaths annually.
- The shot, called Arexvy, is made by British drugmaker GSK (GSK.L) and is designed to protect people aged 60 and over.
- RSV typically causes cold-like symptoms, but is a leading cause of pneumonia in toddlers and the elderly.
- The complex molecular structure of the virus and safety concerns with previous vaccine attempts had stymied efforts to successfully develop a shot since the virus was first discovered in 1956.
- The approval by the European Commission, which follows a recent endorsement from the European Medicines Agency, comes about a month after the U.S. health regulator the gave Arexvy the green light.
- The availability of the vaccine in Europe will depend on national recommendations and reimbursement discussions, but the first launches are expected this autumn ahead of the 2023/2024 RSV season.
- GSK, one of the world's biggest vaccine makers, is relying in part on Arexvy to drive long-term growth, with the pending loss of patent protection for a key HIV compound and setbacks in its marketed oncology portfolio.
- Given the different definitions of the trial endpoints across the GSK and Pfizer trials, a direct comparison of efficacy is difficult.
- The two companies are competing for a slice of an estimated \$13 billion global market for RSV vaccines.
- While Pfizer will be a formidable competitor, GSK thinks it will ultimately capture more than half of the adult RSV market.
- In Europe, RSV leads to over 270,000 hospitalisations and about 20,000 in-hospital deaths in adults over 60 each year.

### About Vaccine for respiratory syncytial virus (RSV)

- RSV is a highly contagious virus that causes infections of the lungs and breathing passages in individuals of all age groups. RSV circulation is seasonal, typically starting during the fall and peaking in the winter.
- In older adults, RSV is a common cause of lower respiratory tract disease (LRTD), which affects the lungs and can cause life-threatening pneumonia and bronchiolitis (swelling of the small airway passages in the lungs).

## Biodegradable Supercapacitor

### Why in News

Recently, scientists at Gujarat Energy Research and Management Institute (GERMI) have developed the thinnest, lightweight and biodegradable paper-based supercapacitor.

### Important Points

#### Biodegradable Supercapacitor:

- A supercapacitor is an electrochemical charge storage device with a fast charging/discharging cycle, high power density and a longer lifecycle.

#### Features

- This supercapacitor which can fully charge a device within 10 seconds, has been developed from seaweed (marine macroalgae).
- The device is of high tensile strength and performance, as well as cost-effective, according to the researchers.
- The product can be used in electronics, memory backup systems, airbags, heavy machines, electric vehicles, etc.; hence, it holds a huge business prospect.
- The marine cellulose-based material used in developing the flexible and thinnest paper supercapacitor can be used in almost all smart electronic devices.
- It can also be a source of revenue for coastal communities that cultivate seaweed, an essential commodity for manufacturing the paper supercapacitor, the researchers noted.
- The supercapacitor device was also tested with various analytical techniques.



## Seaweed

- Seaweeds are macroalgae attached to rock or other substrata and are found in coastal areas.
- They are classified as Chlorophyta (green), Rhodophyta (red) and Phaeophyta (brown) based on their pigmentation.
- Among them, Chlorophyta holds more potential components like carbohydrates, lipids, proteins and bioactive compounds in the cell wall.
- Green seaweed has a high amount of a particular type of cellulose in its cell wall.
- Cellulose is found to be as most suitable biopolymer material for manufacturing paper-based electrode materials such as paper supercapacitors or batteries for energy storage applications.
- Cellulose itself is an insulating material that requires to be coated with conductive material to make a paper-based energy storage device.
- Green seaweeds were collected from the Porbandar coast of Gujarat.
- The developed seaweed-based electrode is used in an asymmetrical supercapacitor by sandwiching a sodium chloride electrolyte-soaked paper separator between two seaweed cellulose nanocomposites and activated charcoal powder slurry.

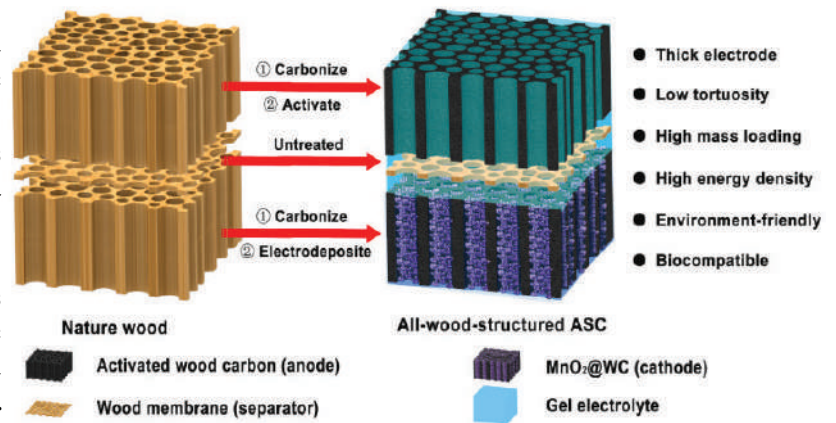

## Einstein Telescope

### Why in News

CERN is helping build and realise the Einstein Telescope, a massive subterranean gravitational wave detector that is expected to be ten times as sensitive as the detectors so far.

### Important Points

- It is an advanced gravitational-wave observatory, currently in the planning stage.
- It builds on the success of current, second-generation laser-interferometric detectors Advanced Virgo and Advanced LIGO, whose breakthrough discoveries of merging black holes (BHs) and neutron stars over the past 5 years have ushered scientists into the new era of gravitational-wave astronomy.
- The Einstein Telescope will achieve a greatly improved sensitivity by increasing the size of the interferometer from the 3km arm length of the Virgo detector to 10km, and by implementing a series of new technologies.
- The expected sensitivity of the Einstein Telescope will be at least a factor of ten times that of Ligo.

### Applications:

- It will make it possible, for the first time, to explore the Universe through gravitational waves along its cosmic history up to the cosmological dark ages, shedding light on open questions of fundamental physics and cosmology.
- It will probe the physics near black-hole horizons (from tests of general relativity to quantum gravity), help understand the nature of dark matter, and the nature of dark energy and possible modifications of general relativity at cosmological scales.
- Its low-frequency sensitivity will allow us to detect intermediate-mass black holes.

### What are Gravitational Waves?

- They are 'ripples' in space-time caused by some of the most violent and energetic processes in the Universe.
- Albert Einstein predicted the existence of gravitational waves in 1916 in his general theory of relativity.
- Einstein's mathematics showed that massive accelerating objects (things like neutron stars or black holes orbiting each other) would disrupt space-time in such a way that 'waves' of undulating space-time would propagate in all directions away from the source.
- These cosmic ripples would travel at the speed of light, carrying with them information about their origins, as well as clues to the nature of gravity itself.
- The strongest gravitational waves are produced by cataclysmic events such as colliding black holes, supernovae, and colliding neutron stars.

## Chiral Bose-Liquid State

### Why in News

According to recent research, the chiral Bose-liquid state may be an entirely new state of matter.

### Important Points

- Usually matter exists in solid, liquid or gas forms.
- At temperatures approaching absolute zero, or the world within the atom, things are very different.
- In these “quantum” states, matter behaves in ways quite different from the solid, liquid, and gaseous states.
- Under frustrated quantum systems, where infinite possibilities result from the interaction of particles.

### How it was formed?

- Researchers used a bi-layer semiconducting device.
- The top layer is electron-rich, and these electrons can move freely.
- The bottom layer is filled with “holes,” or places that a roving electron can occupy.
- Then the two layers are brought extremely close together. The machine is then triggered to create a local imbalance resulting in electrons not having enough holes to fill and this kicks off the novel state called the chiral Bose-liquid state.
- In this state, electrons can be frozen into predictable patterns, making them resilient to changes in spin (a defining characteristic of subatomic particles) and even have electrons synchronise their movements.
- It is very difficult to create such states of matter but going ahead may be used to fashion novel digital encryption systems.



### Quantum states of matter:

- Quantum states of matter exhibit unique behaviours distinct from our familiar solid, liquid, and gaseous states.
- Frustrated quantum systems, in particular, involve the interactions of particles leading to infinite possibilities. In these systems, collisions can produce unexpected outcomes, such as levitating or defying traditional angles.

### What is Chiral?

- The term chiral is from the Greek word for ‘hand’ which refers to anything which cannot be superimposed on its own mirror image.
- The term “chiral” refers to a property in physics where an object or system cannot be superimposed onto its mirror image. In the context of the chiral Bose-liquid state, the term “chiral” is used because the electrons in the chiral Bose-liquid state move or behave differently compared to their mirror-image counterparts, leading to unique and asymmetric characteristics.

## Skin Bank

### Why in News

North India’s first skin bank opens in Safdarjung Hospital

### Important Points

- India has 16 skin banks — a facility where the skin of deceased persons can be donated — with seven in Maharashtra, four in Chennai, three in Karnataka, and one each in Madhya Pradesh and Odisha.
- Skin bank is a facility where skin is taken from an eligible donor and processed and stored under appropriate temperature for upto 5 years.
- The stored skin can be used for Deep burns, chemical burns, electrical burns and radiation burns.



**It's Importance**

- It will help in providing a better quality of life for people suffering from severe burns and injuries.
- The donated skin is usually used as a 'biological dressing' for burns patients.
- The donated skin is used as a temporary dressing so that the wound is healed early and the chances of infection reduce till the patients' skin grows back.
- This dressing can decrease the pain, chances of morbidity, and make the wound optimum for auto grafting.
- Patients of skin infections, skin cancer treatments such as Mohs surgery, skin ulcers, and slow healing or large wounds can all benefit from skin grafting.
- Anyone can be a donor irrespective of sex & blood group. The minimum age of the donor should be 18 years but there is no upper age limit. Even a 100-year-old person can donate his skin and it will be used for treatment. Only those suffering from HIV & Hepatitis B & Hepatitis C, STD'S, generalized infection & Septicemia (Pneumonia, T.B, Etc), any kind of skin infection, malignancy and having evidence of skin cancer, cannot donate.





## Human Organ/Tissue for Transplantation

### Why in News

Government allows Metro to transport organs for transplants

### Important Points

- Human organs and tissue for transplants can be transported via Metro trains now, with the Union Housing and Urban Affairs Ministry notifying a change to the ticket rules for all Metro systems in the country.
- The Ministry notified the Metro Railways (Carriage and Ticket) Amendment Rules, 2023.
- As per the Metro Railways (Carriage and Ticket) Rules, 2014, blood, corpses, bones, human body parts, human skeleton and animal carcasses are considered “offensive materials” that are not allowed on Metro trains.
- The amended rules make an exception for human organs and tissue that is meant for transplantation.
- After the list of prohibited materials, the amendment added a provision: “Provided that a person duly authorised in this behalf by a hospital registered under the Transplantation of Human Organs and Tissues Act, 1994 (42 of 1994), may take along, human organs or tissue or both, for the purpose of organ or tissue transplant.”
- A new Provision has been inserted under Rule 4(2) which allows a person duly authorized by a hospital under the Transplantation of Human Organs and Tissues Act, 1994 to carry human organ/tissue or both for the purpose of transplantation.
- Rule Section 4(2) relates to Prohibition against carriage of dangerous and offensive material.
- According to this Rule no person can take the following items inside metro railway:
  1. blood dried or coagulated or decomposed, whether human or animal;
  2. corpses;
  3. carcasses of dead animals or of dead birds;
  4. bones excluding bleached and cleaned bones; human skeleton;
  5. parts of human body; portable radio devices which possess risk to radio communication network and communication-based traffic control signaling network.



## NGT

### Why in News

National green tribunal (NGT) makes consent from state pollution control board (SPCB) mandatory for river sand mining.

### Important Points

- The National Green Tribunal (NGT) has directed that it will be mandatory to obtain consent to establish or consent to operate from the concerned State Pollution Control Boards for river sand mining and that no river sand mining will be allowed to continue in the country without obtaining these consents with effect from September 1, 2023.
- The tribunal directed the Ministry of Environment, Forest and Climate Change to issue guidelines within two months to ensure that the requirement of obtaining these consents is made uniformly applicable to all river bed sand mining projects across the country.

- The NGT was hearing a matter in which the applicant had raised the issue of illegal sand mining in the Ganga in Kanpur and Unnao along with a bridge allegedly constructed in the river by those carrying out the mining, resulting in the river being divided into two streams.
- Sand mining is extraction of sand, mainly through an open pit but sometimes mined from inland dunes from oceans, riverbeds and beaches.
- It is classified as a 'minor mineral' under section 3(e) of Mines and Mineral (Development and Regulation) i.e., MMDR Act 1957 and administrative control vests with State Governments.

### **Impact of Sand Mining**

- Excessive sand mining can alter the river bed, force the river to change course, erode banks, and cause flooding.
- It causes river and estuary deepening, as well as the expansion of river mouths and coastal inlets.
- It may also result in saline water intrusion from the nearby sea.
- Instream mining can have far-reaching consequences that extend beyond the immediate mine sites.
- Destroys habitat of aquatic animals and micro-organisms besides affecting groundwater recharge
- Riverbed becomes dry due to exposure to solar radiations.
- It affects the homes and livelihoods of people living nearby.
- It also destructs picturesque beaches.
- Sand mining converts the riverbeds into large and deep pits which results in a fall in the groundwater index.
- It has a straight impact on the physical characteristics of the stream, such as channel geometry, bed elevation, substratum composition, stability, flow velocity.

### **Initiatives taken to curb sand mining**

- Sustainable Sand Mining Management Guidelines 2016, issued by MoEFCC, encourages scientific sand mining and environmentally friendly management method.
- Sand Mining Framework, 2018, prepared by Ministry of Mines, envisages alternative sources of sand in form of Manufactured -Sand from crushed rock fines (crusher dust), etc.

### **About National Green Tribunal**

- The National Green Tribunal, established in 2010, as per the National Green Tribunal Act is a specialised judicial body equipped with expertise solely for the purpose of adjudicating environmental cases in the country.
- Recognising that most environment cases involve multi-disciplinary issues which are better addressed in a specialised forum, the Tribunal was setup as per recommendations of the Supreme Court, Law Commission and India's international law obligations to develop national laws on environment and implement them effectively.
- The Tribunal is tasked with providing effective and expeditious remedy in cases relating to environmental protection, conservation of forests and other natural resources and enforcement of any legal right relating to environment. The Tribunal's orders are binding and it has power to grant relief in the form of compensation and damages to affected persons.

### **What is the Tribunal's composition?**

- The Tribunal has a presence in five zones- North, Central, East, South and West. The Principal Bench is situated in the North Zone, headquartered in Delhi.
- The Central zone bench is situated in Bhopal, East zone in Kolkata, South zone in Chennai and West zone in Pune.
- The Tribunal is headed by the Chairperson who sits in the Principal Bench and has at least ten but not more than twenty judicial members and at least ten but not more than twenty expert members.

### **Who may submit cases to the Tribunal and what sort of cases are heard?**

- Any person seeking relief and compensation for environmental damage involving subjects in the legislations mentioned in Schedule I of the National Green Tribunal Act, 2010 may approach the Tribunal.

### **The statutes in Schedule I are:**

- The Water (Prevention and Control of Pollution) Act, 1974;

- The Water (Prevention and Control of Pollution) Cess Act, 1977;
- The Forest (Conservation) Act, 1980;
- The Air (Prevention and Control of Pollution) Act, 1981;
- The Environment (Protection) Act, 1986;
- The Public Liability Insurance Act, 1991;
- The Biological Diversity Act, 2002.
- The Tribunal has jurisdiction over all civil cases involving a substantial question relating to environment and the question. Additionally, any person aggrieved by an order/direction of any of the Appellate Authorities under the legislations mentioned above can also challenge them before the National Green Tribunal.

#### Are decisions of the Court binding?

- Yes, decisions of the Tribunal are binding. The Tribunal's orders are enforceable as the powers vested are the same as in a civil court under the Code of Civil Procedure, 1908.

## Telegram Bots

### Why in News

Recently, reports emerged alleging that a Telegram bot had unauthorized access to and was exposing individuals' identification numbers.

### Important Points

- It was claimed that a Telegram bot was revealing sensitive data of the users when inquired about an individual's phone number.
- The bot leaked the name, Aadhaar number, PAN number, passport number, date of birth, location, gender, and the institute from where they got vaccinated.
- Notably, a user had to save some of these details while registering for the CoWIN app.
- Millions of Indian users had signed up on CoWIN portal, launched on January 16, 2021, and have used it to book vaccination slots.
- The data includes more than 40 million children aged between 12-14 and over 37 million people over the age of 45, a significant part of which could be senior citizens.
- Now, it is no longer possible to access this bot.

### Indian government's response

- There were two, slightly different, reactions from the government.
- The first one was issued by the Indian health ministry which outrightly rejected claims of data leak saying that "all such reports are without any basis and mischievous in nature".
- In a press release, the health ministry said that there are three ways in which data on CoWIN can be accessed.
- First, a user can access their data on the portal through a one-time password (OTP) sent to their mobile number.
- Two, a vaccinator can access the data of a person, and the CoWIN system tracks and records each time an "authorised" user accesses the system.
- And lastly, third-party applications that have been provided authorised access of CoWIN APIs can access personal level data of vaccinated people after OTP authentication.
- The government claimed that without an OTP, data cannot be shared with the Telegram bot.
- The ministry further pointed out that CoWIN only collects their year of birth while there is no provision to save a person's address on the platform.
- The health ministry has roped in the Indian Computer Emergency Response Team (CERT-In)—the Indian nodal government agency that looks after cyber security—to look into this issue and submit a report. In addition, an internal exercise has been initiated to review the existing security measures of CoWIN.
- A Telegram Bot was throwing up Cowin app details upon entry of phone numbers.
- The data was being accessed by bot from a threat actor database, which seems to have been populated with previously stolen data.



**What is a bot?**

- A bot, short for robot, is a software application programmed to perform tasks through Robotic Process Automation, or RPA.
- Bots work by automatically going through a set of instructions, and they carry out tasks and processes much faster, more accurately, and at a higher volume than it would otherwise take humans.
- On Telegram, every bot has a unique handle.
- To add a bot, one has to simply search for it, click on the bot handle and they will be able to interact with it in the chat window.
- These bots can support “any kind of task or service,” with some popular functions including delivering answers to users’ FAQs, converting certain file types into others, or setting reminders for users.
- However, of late, there has been sharp increase in mishandling bots and primarily used to run scams, or exfiltrate personal data.

**Can a bot threaten privacy of users?**

- Apparently yes, One of the main concerns raised about chatbots is the collection of personal information. Many chatbots collect user data, including their conversations, personal preferences, and location.
- Though this data is used to personalise the chatbot responses and improve the user experience, there have been many instances where it is used for scams and identity thefts, spread malware and launch cyberattacks.

**What is CoWIN and how does it work?**

- CoWIN, which stands for COVID-19 Vaccine Intelligence Network, is an app introduced and made under the aegis of the central government for the vaccination process.
- It serves various services like registration, beneficiary tracking, appointment scheduling, vaccine stock management, real-time data monitoring, identity verification, vaccination, and issuing an instant digital certificate to each vaccinated individual.
- CoWIN has so far recorded more than 2.2 billion administered vaccine doses through 5,773 vaccination sites.

**UNSDC Framework 2023-2027****Why in News**

NITI Aayog and the United Nations in India signed the Government of India – United Nations Sustainable Development Cooperation Framework 2023–2027.

**Important Points**

- GoI-UNSDC framework represents the UN development system’s collective offer to the Government of India, in line with the national vision for development, for the achievement of the Sustainable Development Goals, promoting gender equality, youth empowerment and human rights.
- It is built on four strategic pillars derived from the 2030 Agenda – People, Prosperity, Planet and Participation.
- The four interlinked pillars have six outcome areas focusing on Health and Well Being; Nutrition and Food Security; Quality Education; Economic Growth and Decent Work; Environment, Climate, WASH and Resilience; and Empowering People, Communities, and Institutions.
- It will have a specific focus on SDG localisation and South-South cooperation, in line with India’s leadership towards the implementation and acceleration of the SDGs; and India’s championing of South-South cooperation.
- The implementation and monitoring will be co-led by the Government of India and the United Nations, India through a Joint Steering Committee.
- UNSDCF has been designated as principal planning and implementation instrument for UN Development System at country level.

**Focus:**

- The GoI-UNSDCF places specific emphasis on SDG localisation and South-South Cooperation, aligning with India’s leadership in implementing and accelerating the SDGs.
- SDG localization is the process of transforming the SDGs into reality at the local level, in line with national frameworks and with communities’ priorities.
- India aims to showcase its development models globally and actively promotes South-South cooperation.

### Implementation and Monitoring:

- The implementation, monitoring, and reporting of the GoI-UNSDCF 2023-2027 will be jointly led by the Government of India and the United Nations, India through a Joint Steering Committee.

### Sustainable Development Goals

- The Sustainable Development Goals (SDGs), also known as the Global Goals, were adopted by the United Nations in 2015 as a universal call to action to end poverty, protect the planet, and ensure that by 2030 all people enjoy peace and prosperity.
- It is a set of 17 SDGs which recognize that action in one area will affect outcomes in others and that development must balance social, economic, and environmental sustainability.
- Countries have committed to prioritizing progress for those who are furthest behind.
- The SDGs are designed to end poverty, hunger, AIDS, and discrimination against women.
- India in recent years has made significant efforts in achieving the Goal 13th of the SDGs in particular.
- The goal calls for taking urgent action to combat climate change and its impacts.



## Sustainability Report

### Why in News

National highways authority of INDIA (NHAI) released its first 'sustainability report for financial year 2021-22'.

### Important Points

- NHAI's first 'Sustainability Report for FY 2021-22' covers NHAI's governance structure, stakeholders, environment and social responsibility initiatives.
- The report was recently released by the Union Ministry for Road Transport and Highways.

### Key findings of report

- The Sustainability Report underlines the effectiveness of various efforts made by NHAI for environment and energy conservation.
- From FY 2019-20 till 2021-22 direct emission reduced by 18.44% and 9.49% due to less fuel consumption.
- NHAI continues to work towards reducing indirect emissions as well, by transiting towards clean and green energy sources.
- Green House Gas (GHG) Emissions from energy consumption, operations, transport and travel measured in Metric Tonnes CO<sub>2</sub> equivalent /km constructed saw a decline of 9.7% in FY 2020-21 and 2% in FY 2021-22.
- Similarly in operations, energy intensity in Giga Joules/km reduced by 37% in FY 2020-21 and 27% in FY 2021-22, while the kilometers constructed through the reporting period has risen steadily.
- With over 97 percent penetration, Electronic Toll Collection through FASTag has contributed to reduce the carbon footprint.
- NHAI has been using recycled materials for National Highway construction. Use of fly-ash and plastic waste in construction has increased over the last three years.
- NHAI has been encouraging use of Recycled Asphalt (RAP) and Recycled Aggregates (RA) in the National Highway construction.
- NHAI has partnered with different stakeholders such as State Rural Livelihood Mission (SRLM), Self Help Groups, CSR partners and NGOs to collaboratively organize plantation drives.



- In July 2022, NHAI organized a nationwide plantation drive and planted around 1.1 lakh plants in a single day through simultaneous plantations at 114 identified locations across the country.
- NHAI's Sustainability Report is not a mandated requirement as per SEBI guidelines, but this has been taken as a voluntary initiative to demonstrate its sustainability credentials and is prepared as per the Global Reporting Initiative (GRI) reporting guidelines.
- The report has been externally assured by a third party adhering to International Standards on Assurance Engagements. This Sustainability Report will open new avenues for infrastructure financing known as 'Green Finance' as per Ministry of Finance, Government of India framework.
- NHAI has taken significant steps towards adopting sustainable and eco-friendly practices, including the use of renewable energy sources, promoting green highways, and adopting waste management practices.
- Going forward, NHAI remains committed to ensure that its projects are not only economically viable but also socially responsible and environmentally sustainable.

### About NHAI

- NHAI, set up through NHAI Act, 1988, is responsible for development, maintenance, and management of National Highways across India.
- It is a nodal agency of Ministry of Road Transport and Highways (MoRTH) and is mandated to implement National Highways Development Project.

## Manual Scavenging

### Why in News

Only 66% districts in country free of manual scavenging as per Social Justice Ministry report

### Important Points

- Recently, the Union Ministry of Social Justice and Empowerment has mentioned that in India, only 508 districts out of the total 766 districts in the country have declared themselves manual-scavenging free.

### Background

- In April 2022, the Centre said that there have been no manual scavenging deaths in the country but 161 workers died cleaning sewers and septic tanks in the last three years.
- Tamil Nadu reported the highest number of such deaths at 27 followed by 26 in Uttar Pradesh, according to government data.

### Highlights of the report

- The report highlighted that only 66% districts in country free of manual scavenging.
- Under the report the ministry has differentiated 'manual scavenging' from 'hazardous cleaning of sewers'.

### What is Manual Scavenging?

- Manual evacuation refers to the process of removing human and animal waste from dry toilets and transporting it for disposal.
- As per the "Prohibition of Employment as Manual Scavengers and their Rehabilitation Act, 2013 (MS Act, 2013)" manual scavenging means manually cleaning, carrying, disposing of, or handling in any manner, human excreta in an insanitary latrine.
- It is prohibited with effect from December 2013.
- It was officially banned by the anti-manual scavenging Act in 1993 as a degrading practice.

### Laws related to manual scavenging

- The Prohibition of Employment as Manual Scavengers and their Rehabilitation Act, 2013 prohibits the construction or maintenance of unhygienic toilets, and the hiring of any person by hand cleaning or hazardous cleaning of sewer pipes and swimming pools.
- Article 21: The Article guarantees the 'Right to Life' and also with dignity.
  - Swachh Bharat Abhiyaan (Clean India initiative)
  - Safaimitra Suraksha Challenge
  - Swachhta Abhiyan App
- Amendment Act: Introduction of 'The Prohibition of Employment as Manual Scavengers and their Rehabilitation (Amendment) Bill, 2020' as part of the National Action Plan for the Department of Justice and Empowerment.



- **Mechanical Cleaning:** The Bill proposes to completely clean sewage systems and provide better occupational safety and compensation in the event of an accident.

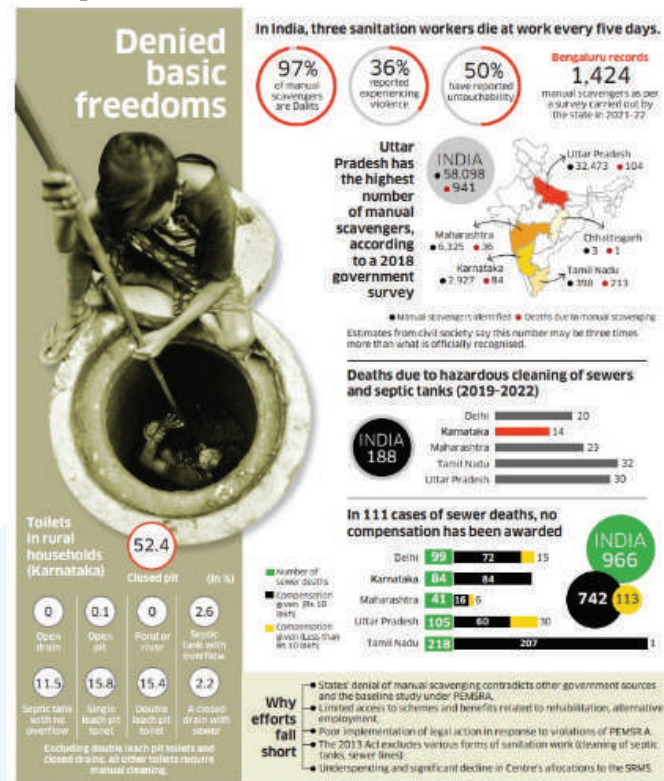

### Government Initiatives

- According to the scheme for rehabilitation of manual scavengers, the 58,000 identified sewer workers have been given a one-time cash pay-out of ₹40,000 each.
- In addition, around 22,000 of them (less than half) have been connected to skills training programmes.
- However, the scheme for rehabilitation of manual scavengers has now been merged with the NAMASTE scheme for 100% mechanisation of sewer work.
- The FY 2023-24 Union Budget showed no allocation for the rehabilitation scheme and ₹100 crore allocations for the NAMASTE scheme.

### Technological development

- The Indian Institute of Technology (IIT) Madras has developed a robot with the aim to eliminate manual scavenging in India.
- Around 10 units will be deployed across Tamil Nadu and the plan is to put them to use in Gujarat and Maharashtra next.

## Gender Gap Report, 2023

### Why in News

The World Economic Forum recently released the annual Gender Gap Report for 2023.

### Important Points

- India was ranked at 127 out of 146 countries in terms of gender parity — an improvement of eight places from last year, according to the recently published annual Gender Gap Report, 2023.

### Global Gender Gap Index

- Gender Gap is the disparity between men and women in terms of their social, political, intellectual, cultural, or economic empowerment, achievements or developments.
- It is the longest-standing index which tracks progress on closing these gaps since its inception in 2006.
- It also explores the impact of recent global shocks on the gender gap crisis in the labour market.
- Global Gender Gap Index is the benchmark index released by the World Economic Forum in 2006, evaluates and compares nations' advancements toward gender parity and equality over four key dimensions with sub-parameters.

### Key Dimensions:

- Economic Participation and Opportunity
- Educational Attainment
- Health and Survival
- Political Empowerment

### India's Performance

- India has made some progress in terms of gender parity. It has moved up eight positions compared to the previous year and is now ranked 127th out of 146 countries. In the 2022 edition, India was ranked 135th.
- India has improved by 1.4 percentage points and eight positions since the last edition, marking a partial recovery towards its 2020 parity level.
- India has achieved parity in enrolment across all levels of education, which is a positive development.
- India has closed 64.3% of the overall gender gap.
- However, when it comes to economic participation and opportunity, India still lags behind, with only 36.7% parity in this area.

### India's position on different indices:

- In India, although there has been an increase in wage and income parity, there has been a slight decrease in the representation of women in senior positions and technical roles.
- India has made progress with a parity rate of 25.3%, and women now account for 15.1% of parliamentarians.
- In terms of women's representation in local governance, out of the 117 countries with available data since 2017, 18 countries have achieved over 40% women's representation, including Bolivia (50.4%), India (44.4%), and France (42.3%).
- India has seen a 1.9 percentage point improvement in the sex ratio at birth, which has contributed to overall parity after more than a decade of slow progress.

### Indian Initiatives to reduce Gender Gap

- **Beti Bachao Beti Padhao:** It ensures the protection, survival and education of the girl child.
- **Mahila Shakti Kendra:** It aims to empower rural women with opportunities for skill development and employment.
- **Mahila Police Volunteers:** It envisages engagement of Mahila Police Volunteers in States/UTs who act as a link between police and community and facilitates women in distress.
- **Rashtriya Mahila Kosh:** It is an apex microfinance organization that provides micro-credit at concessional terms to poor women for various livelihood and income generating activities.
- **Sukanya Samridhi Yojna:** Under this scheme girls have been economically empowered by opening their bank accounts.
- **Female Entrepreneurship:** To promote female entrepreneurship, the Government has initiated Programmes like Stand-Up India and Mahila e-Haat (online marketing platform to support women entrepreneurs/ SHGs/NGOs), Entrepreneurship and Skill Development Programme (ESSDP).
- **Kasturba Gandhi Balika Vidyalaya:** They have been opened in Educationally Backward Blocks (EBBs).

Global Gender Gap Index 2023

#### Global, Top 10

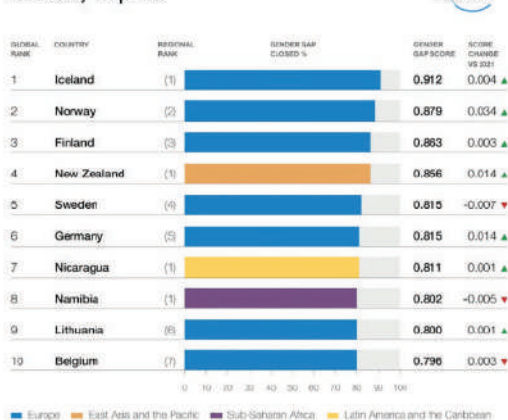

Global Gender Gap Index 2023

#### At current pace, when are the regions likely to close the gender gap?

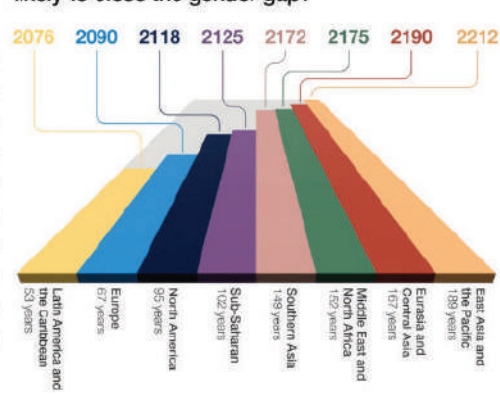

## Gender Social Norms Index (GSNI) 2023

### Why in News

Recently, the United Nations Development Programme (UNDP) released the Gender Social Norms Index (GSNI) 2023.

### Important Points

#### About Gender Social Norms Index (GSNI) 2023:

- It quantifies biases against women, capturing people's attitudes toward women's roles.
- It tracked people's attitudes towards women in four dimensions: political, educational, economic and physical integrity.

#### Key Findings

- **Biased Gender Social Norms:** Biased gender social norms pose a significant obstacle to achieving gender equality and empowering women and girls, as outlined in the Sustainable Development Goals (SDGs). These norms undervalue women's capabilities and rights, limiting their choices and opportunities.
- **Global Prevalence:** Gender bias is prevalent globally. The Gender Social Norms Index (GSNI) measures biases against women across four dimensions: political, educational, economic, and physical integrity. The index reveals that nearly 9 out of 10 men and women hold biases against women.
- **Approximately half of the world's population believes that men make better political leaders, and two out of five people believe that men make better business executives.**
- **Global Issue:** Gender biases persist across regions, income levels, and cultures, making them a global issue. These biases are evident in both lower and higher Human Development Index (HDI) countries.
- **Stagnation of Progress:** The GSNI values have stagnated over the past decade, indicating limited overall progress in challenging biased gender social norms. Despite powerful campaigns for women's rights, such as Me Too, and Time's Up, little progress has been made.
- **Economic Implications:** Biased gender social norms hinder women's economic empowerment. Recent evidence suggests a broken link between women's access to education and their achievements in economic empowerment.
- **Educational Disparities:** Income gaps between women and men are more strongly correlated with measures of gender social norms than with educational disparities. Countries with higher bias in gender social norms tend to witness a disproportionate burden on women for domestic chores and care work.
- **Political Representation:** Despite the removal of many formal barriers to women holding political office in most countries, gender gaps in political representation persist.
- **The share of women as heads of state or government has remained around 10 percent worldwide since 1995, and women hold just over a quarter of parliament seats globally.**
- **Women leaders often face harsher judgment than their male counterparts, and changes in social norms can either foster greater acceptance of women's leadership or stronger backlash against it.**
- **Societal Impact:** Biased gender social norms not only limit women's freedoms and choices but also deprive societies of the benefits of women's leadership. Social norms that inhibit women's representation in decision-making prevent the inclusion of diverse perspectives, experiences, abilities, voices, and ideas.

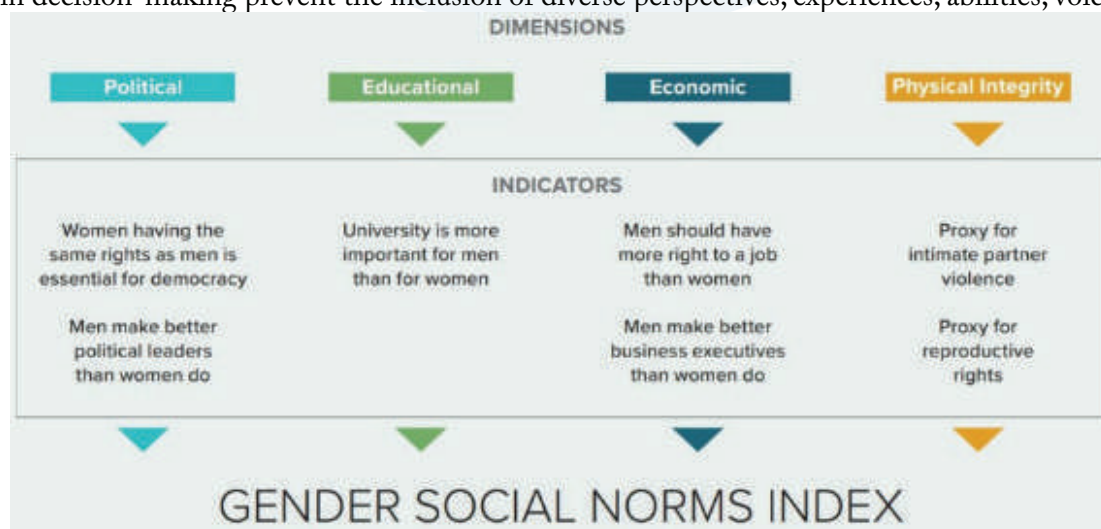



## Global Slavery Index 2023

### Why in News

According to Global Slavery Index 2023, on any given day in 2021, as many as 50 million people were living in “modern slavery”.

### Important Points

- The Global Slavery Index (GSI) provides national estimates of modern slavery for 160 countries.
- It is presented by Walk Free, a human rights organisation, and is based on data provided by the Global Estimates of Modern Slavery, which, in turn, is produced by the International Labour Organisation (ILO), Walk Free, and the International Organisation for Migration (IOM).
- This is the fifth edition of the GSI and it is based on the 2022 estimates. The previous four editions were published in 2013, 2014, 2016, and 2018.
- In its report, Walk Free reported that 49.6 million people are living in modern slavery, out of which, India is home to 11 million.
- The organisation, Walk Free, says that “modern slavery is hidden in plain sight and is deeply intertwined with life in every corner of the world”.
- An estimated 50 million people were living in modern slavery on any given day in 2021, an increase of 10 million people since 2016, according to Walk Free. Among these 50 million (of which 12 million are children), 28 million suffer from forced labour and 22 million from forced marriages.
- The Sustainable Development Goals (SDGs) of the United Nations resolve to end modern slavery. Target 8.7 of the SDGs states
- Take immediate and effective measures to eradicate forced labour, end modern slavery and human trafficking and secure the prohibition and elimination of the worst forms of child labour, including recruitment and use of child soldiers, and by 2025, end child labour in all its forms.

### What is Modern slavery?

- It refers to situations of exploitation that a person cannot refuse or leave because of threats, violence, coercion, deception, or abuses of power.
- It is an umbrella term and includes a whole variety of abuses such as forced labour, forced marriage, debt bondage, sexual exploitation, human trafficking, slavery-like practices, forced or servile marriage, and the sale and exploitation of children.

### There are three sets of key findings.

- The first set consists of countries that top in terms of the prevalence of modern slavery. The prevalence refers to the incidence of modern slavery per 1,000 population.
- On this count, the following 10 countries are the worst offenders: North Korea, Eritrea, Mauritania, Saudi Arabia, Turkey, Tajikistan, the UAE, Russia, Afghanistan, and Kuwait.
- The index states that “These countries share some political, social, and economic characteristics, including limited protections for civil liberties and human rights.”

- The second set consists of countries with the lowest prevalence. The list includes countries such as Switzerland, Norway, Germany, Netherlands, Sweden, Denmark, Belgium, Ireland, Japan, and Finland.

- The third set consists of countries hosting the maximum number of people living in modern slavery. The list is as follows: India, China, North Korea, Pakistan, Russia, Indonesia, Nigeria, Turkey, Bangladesh, and the US.

#### Most prevalent

The countries estimated to have the highest prevalence of modern slavery tend to be conflict-affected, have state-imposed forced labour, and have weak governance.

	Rank	Prevalence Rate*	# of People
North Korea	1	104.6	2,696,000
Eritrea	2	90.3	320,000
Mauritania	3	32.0	149,000
Saudi Arabia	4	21.3	740,000
Türkiye	5	15.6	1,320,000
Tajikistan	6	14.0	133,000
United Arab Emirates	7	13.4	132,000
Russia	8	11.0	1,899,000
Afghanistan	9	13.0	505,000
Kuwait	10	13.0	55,000

#### Least prevalent

The countries with the lowest prevalence of modern slavery are those with strong governance and strong government responses to modern slavery.

	Rank	Prevalence Rate*	# of People
Switzerland	160	0.5	4,000
Norway	159	0.5	3,000
Germany	158	0.6	47,000
Netherlands	157	0.6	10,000
Sweden	156	0.6	6,000
Denmark	155	0.6	4,000
Belgium	154	1.0	11,000
Ireland	153	1.1	5,000
Japan	152	1.1	144,000
Finland	151	1.4	8,000

- The index states that “Collectively, these countries account for nearly two in every three people living in modern slavery and over half the world’s population. Notably, six are G20 nations: India, China, Russia, Indonesia, Turkey, and the US.”

## UN postal agency

### Why in News

India approves UN postal agency regional office in Delhi to expand diplomatic reach

### Important Points

- The Centre has decided to establish a regional office of the Universal Postal Union (UPU) in India in a bid to enhance its role in the postal sector and strengthen international relations.
- The decision, taken in a meeting of the Union Cabinet chaired by Prime Minister and was announced by Union Minister.
- Following an agreement with the United Nations agency, India is planning to actively participate in multilateral organisations in the postal sector, with a special focus on South-South and Triangular cooperation.
- Through the partnership, India aims to undertake UPU's development cooperation and technical assistance activities.
- As a part of the deal, the government will provide a field project expert, along with staff and office infrastructure for the UPU regional office.
- Through this project, India will prepare and implement projects and training programmes on capacity building, enhancing the efficiency and quality of postal services, and promoting postal technology, e-commerce and trade in cooperation with the UPU.
- According to a statement issued by the Centre, the initiative will have far-reaching benefits, not only for India but also for other Asia-Pacific region countries.
- The establishment of the UPU regional office will expand India's diplomatic footprint, strengthen its relations with other nations and enhance its presence in global postal forums.
- India joined the UPU in 1876, two years after the international organisation was established.
- According to the UPU, there are 20 contribution units in India and India Post is the designated operator.
- The UPU recently inaugurated a new regional office at Suva in Fiji.
- In November 2022, the agency announced the opening of its new regional office in Uruguay.



### Universal Postal Union

- The Universal Postal Union is a specialised agency of the United Nations that coordinates postal policies between its sovereign member nations.
- Headquartered in Bern, Switzerland, the UPU has 192 member countries.
- It serves as the primary forum for cooperation between postal sector players and helps to ensure a universal network of up-to-date products and services.
- It performs an advisory, mediating and liaison role, providing technical assistance to member countries where needed.
- The UPU sets the rules for international mail exchange and makes recommendations to enhance growth in mail, parcel and financial services volumes.

## India and Nepal

### Why in News

India and Nepal sign pacts on energy and transport

### Important Points

- Two nations inked seven pacts, including in infrastructure and connectivity and concluded a long-term power trade agreement under which India will be importing 10,000 MW of electricity from Nepal in the next 10 years.
- Both nations signed the Treaty of Transit, which will give Nepal access to Indian inland waterways apart from new railway lines.
- Revision of the Transit Treaty: Nepal now has access to India's inland waterways thanks to the revision of the Transit Treaty that was signed. This accord is considered a "once in a generation" pact and is viewed as a significant milestone.
- India announced the ramping up of infrastructure and development assistance to Nepal, including in the spheres of railway and inland water connectivity, power transmission, hydropower projects, irrigation, integrated checkpoints and financial connectivity.
- India will also fund three power transmission corridors under a \$680 million line of credit to Nepal.
- It was also decided that hydropower will be supplied from Nepal to Bangladesh via the Indian grid and the three countries are expected to ink a pact in due course.
- Cooperation on the economy: India is Nepal's top trading partner and the main source of FDI. There is a significant amount of trade between the two nations, spanning many different goods and services.
- Development Assistance: India has been offering Nepal development support in some areas, including infrastructure, education, health, and agriculture. These initiatives are meant to aid Nepal's socioeconomic growth.
- Open borders and intercultural exchanges: Citizens of India and Nepal can travel without a visa thanks to the countries' open border policies. This makes it easier for people to interact widely, exchange cultures, and go on vacation.
- Security collaboration: India and Nepal have a history of working together to combat terrorism and cross-border crime. This cooperation includes intelligence sharing.
- Hydroelectric and water resources: India has helped Nepal construct its hydroelectric plants. Nepal has abundant water resources. Cooperation in this area may increase Nepal's ability to produce energy and meet its own energy needs.
- Project with Multiple Uses at Pancheshwar: The two prime ministers pledged to make real, time-bound progress on the project with Multiple Uses at Pancheshwar. The goal of this initiative is to improve bilateral collaboration in the areas of hydropower production and irrigation.
- Border disputes: On occasion, India and Nepal have run into problems along their shared border, particularly when it comes to defining it. In the past, these disagreements have raised tensions, but they have typically been settled via discussion and negotiation.
- Cultural Exchange: Exchanges in the arts and sciences are encouraged by India and Nepal to deepen intercultural relations. Scholarships and other financial aid are offered by Indian educational institutions to Nepalese students who wish to study there.



### Projects were launched

- Several projects were launched including the handing over of the Kurtha-Bijalpura section of the railway line, the inaugural run of an Indian Railways cargo train from Bathnaha (India) to Nepal customs yard, which is the newly constructed rail link under Indian grant, the inauguration of integrated checkposts (ICPs) at Nepalgunj (Nepal) and Rupaidiha (India), the ground breaking ceremony of ICPs at Bhairahawa (Nepal) and Sonauli (India), the ground breaking ceremony of the Motihari-Amlekhgunj petroleum pipeline phase II facilities and the ground breaking ceremony of the Indian portion of Gorakhpur-Butwal transmission line.



- India and Nepal signed MoUs for cooperation in the field of petroleum infrastructure, for the development of infrastructure at the Dodhara Chandani check post along the Indo-Nepal border, the Phukot Karnali Hydroelectric Project, cross-border payments and an MoU between the Sushma Swaraj Institute of Foreign Service and the Institute of Foreign Affairs, along with a project development agreement for the Lower Arun Hydroelectric Project.

## ICC arrest warrant

### Why in News

S.Africa mulls options on ICC arrest warrant for potential visitor Putin

### Important Points

- South Africa is mulling legal options if Russian President Vladimir Putin, the subject of a war crimes arrest warrant, attends a BRICS emerging economies summit in Johannesburg in August 2023.
- The International Criminal Court has issued a warrant for Putin related to Russia's invasion of Ukraine, and South Africa as an ICC member would theoretically be required to arrest him if he attends the BRICS summit.
- Invitations have been issued to all heads of state from Brazil, Russia, India, China and South Africa for the Aug. 22-24 summit in Johannesburg.
- The ICC issued the warrant for Putin in March, accusing him of the war crime of forcibly deporting children from Russian-occupied territory in Ukraine. Moscow denies the allegations.
- One option gaining traction among South African officials would be to ask BRICS' previous chair China to host the summit.
- South Africa issued diplomatic immunity to all leaders attending both the BRICS foreign ministers meeting and the August summit.
- The international relations department said this was standard procedure, however, for all international conferences in South Africa.
- These immunities do not override any warrant that may have been issued by any international tribunal against any attendee of the conference.
- South Africa previously signalled its intention to quit the ICC after protests over its failure in 2015 to arrest then-Sudanese president Omar al-Bashir, wanted on genocide charges, when he attended an African Union summit in Johannesburg.
- But the governing African National Congress decided in December that South Africa should abandon this process and try to effect changes to the ICC from within.

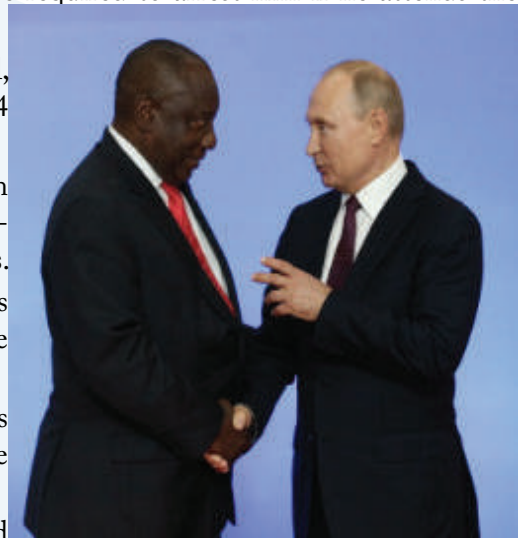

### About ICC

- It is an international court to investigate and prosecute individuals accused of serious international crimes: genocide, crimes against humanity, war crimes, and aggression.
- It was established by the Rome Statute of the International Criminal Court in 1998.
- It has jurisdiction only over crimes committed after July 1, 2002, when the Rome Statute entered into force.
- The Court does not have its own police force. Accordingly, it relies on State cooperation, which is essential to the arrest and surrender of suspects.
- There are 123 countries party to the Rome Statute.
- Countries that never signed the treaty: India, China, Iraq, North Korea, Saudi Arabia, Turkey, etc
- Countries signed but not ratified the treaty: Egypt, Iran, Israel, Russia, the United States, etc
- Member country can refer situation within its territory to the court.
- UN Security Council can refer to a situation in this all-UN Member States must cooperate regardless of party status.
- Prosecutor can initiate an investigation into member state.

# 11th Edition of the World of Work Report

## Why in News

The International Labour Organisation (ILO) has released its 11th edition of the World of Work report, providing insights into the projected global unemployment rates and the need for social protection.

## Important Points

- As the world recovers from the impact of the pandemic, it is crucial to address the disparities in employment opportunities and foster economic stability.

## Projected Global Unemployment Rate

- According to the ILO, the projected global unemployment rate for 2023 is expected to fall below pre-pandemic levels, reaching 5.3%, which corresponds to approximately 191 million individuals. While this indicates a positive trend, it is essential to consider the varying degrees of recovery among different regions and income groups.

## Regions with Reduced Unemployment Rates

- The report highlights regions that have successfully reduced their unemployment rates below pre-crisis levels. Latin America and the Caribbean, northern, southern, and western Europe, and central and Western Asia have demonstrated resilience in their labor markets, with unemployment rates ranging from 6.3% to 6.7%, showing a positive recovery trend.

## Introducing the Jobs Gap Indicator

- To measure the unmet demand for employment, especially in developing countries, the ILO has introduced a new indicator called the jobs gap. This indicator encompasses all individuals who desire employment but are currently jobless. It provides a comprehensive measure of the employment challenges faced globally.

## Challenges for Low-Income Countries

- Low-income countries face significant obstacles in closing the jobs gap. The report reveals that the jobs gap rate for these countries stands at a staggering 21.5%. Furthermore, this rate has increased from 19.1% in 2005 to 21.5% in 2023, highlighting the persistent employment challenges they encounter.

## Rising Debt Levels and Policy Interventions

- Developing countries also face additional challenges due to rising debt levels, which constrain their ability to implement effective policy interventions. This limitation hampers responses to complex threats and reinforces the existing employment divide between high-income and low-income countries.

## The Benefits of Social Protection

- The report emphasizes the importance of social protection policies in reducing disparities and fostering economic growth. Introducing universal basic old-age pensions in developing countries, for example, would lead to a 14.8% increase in GDP per capita within a decade and a significant reduction in extreme poverty by 6 percentage points.

## The Need for Global Financial Support

- To ensure a comprehensive recovery and bridge the employment gap, the report advocates for global financial support for job creation and social protection. By investing in these areas, countries can work towards narrowing the gap between rich and poor nations and fostering long-term economic stability.

## About International Labour Organization (ILO)

- It was established by the Treaty of Versailles in 1919.
- Its founders had made great strides in social thought and action before the establishment of the organization itself.
- It became the first specialised agency of the United Nations (UN) in the year 1946.
- The ILO has played a significant role in promoting labour and human rights. It had held a significant position during the Great Depression (1930s) for ensuring labour rights.

## Objective

- To develop and effectuate standards, fundamental principles, and fundamental rights at work.
- To ensure that men and women have equal access to decent work while enhancing opportunities for the same.
- To magnify the coverage and effectiveness of social protection for everyone.
- To strengthen Tripartism and social dialogue.



### The three organs of the ILO are:

- International Labour Conferences: - General Assembly of the ILO – Meets every year in the month of June.
- Governing Body: - Executive Council of the ILO. Meets three times in a year in the months of March, June and November.
- International Labour Office: - A permanent secretariat.
- The work of the Conference and the Governing Body is supplemented by Regional Conferences, Regional Advisory Committees, Industrial and Analogous Committees, Committee of Experts, Panels of Consultants, Special Conference and meetings, etc.

## Henley Private Wealth Migration Report 2023

### Why in News

As per Report, 6,500 high net worth individuals likely to exit India in 2023.

### Important Points

- India is expected to see the exit of 6,500 high-net-worth individuals (HNWIs) in 2023, the second-highest estimated outflow number globally, as per the latest Henley Private Wealth Migration Report 2023.
- Although the second-biggest loser globally, India's net exit numbers are predicted to drop to 6,500 in 2023 compared to last year's 7,500, the report said.

### Net outflows of HNWI

- With reference to other countries, this number of 6,500 for India for 2023 compares with expected net outflow of 13,500 HNWI in China, 3,200 HNWI in the UK and 3,000 in Russia.
- UK's anticipated HNWI flight is double that of last year, when it saw a net exodus of 1,600 millionaires.
- These outflows are not particularly concerning as India produces far more new millionaires than it loses to migration.
- As India has for the past decade, China continues to lose the largest numbers of dollar millionaires each year to migration. General wealth growth in China has been slowing over the past few years, which means that the recent outflows could be more damaging than usual.
- China's economy grew strongly from 2000 to 2017, but wealth and millionaire growth in the country has been negligible since then (when measured in US-dollar terms).

### Net inflow of HNWI

- Australia is expected to attract the highest net inflow of HNWI in 2023 at 5,200.
- The UAE has dropped to second place following its record-breaking influx in 2022, with a net arrival of 4,500 new millionaires 2023.
- Singapore ranks third with a net inflow of 3,200 HNWI, its highest on record, followed by the US with an expected net influx of 2,100 millionaires.
- At fifth place is Switzerland with expected net inflow of 1,800, followed by Canada with 1,600 HNWI.
- These countries are followed by Greece (1,200), France (1,000 — double last year's net intake of 500 millionaires), Portugal (800), and New Zealand (700).
- Israel is predicted to tumble out of the top 10 with its net inflow of millionaires set to almost halve this year to 600 compared to 1,100 in 2022.
- America is notably less popular among migrating millionaires today than pre-Covid, perhaps owing in part to the threat of higher taxes.
- The country still attracts more HNWI than it loses to emigration, with a net inflow of 2,100 projected for 2023, although this is a staggering drop from 2019 levels, which saw a net inflow of 10,800 millionaires.

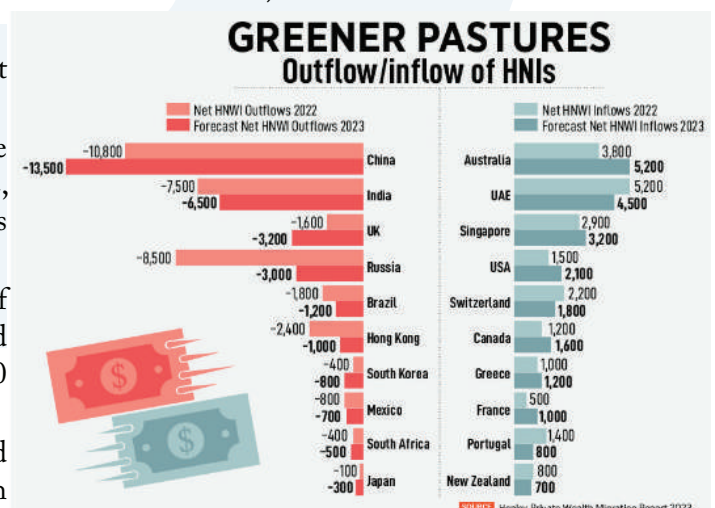



## Investment migration pathways

As per the report, the popular investment migration pathways include:

- Portugal's Golden Residence Permit Program,
- Austria's citizenship by investment offering and
- St. Kitts and Nevis's Citizenship by Investment Program.
- Next is Canada's Start-Up Visa Program, the fastest way for entrepreneurs and wealthy individuals to access Canadian residence and the North American market.
- Rising in popularity this year and last in the top five is Italy's Residence by Investment Program with Greece's Golden Visa Program and
- Spain's Residence by Investment Program.

### Methodology

- The data in the Henley Private Wealth Migration Dashboard is supplied by wealth intelligence firm, New World Wealth, and covers key countries in five regions (Africa, the Americas, Asia Pacific, Europe and CIS, and the Middle East).
- New World Wealth tracks global wealth migration trends between countries and cities.
- Millionaires' or 'high-net-worth individuals' (HNWIs) refer to those with investable wealth of US \$1 million or more.
- The report released by international residence and citizenship advisory firm Henley & Partners features the latest net inflows and outflows of dollar millionaires (the difference between the number of HNWIs with investable wealth of USD 1 million or more who relocate to and the number who emigrate from a country).
- The HNWI migration figures focus on HNWIs who stay in their new country more than six months a year.

## Armenia and Azerbaijan

### Why in news

Armenia accuses Azerbaijan of 'ethnic cleansing' in Nagorno-Karabakh.

### Important Points

- Armenia accused Azerbaijan of pursuing a policy of "ethnic cleansing" in the Armenian-populated region of Nagorno-Karabakh, at the center of a decades-long territorial dispute between the Caucasus arch-foes.
- Azerbaijan set up a border checkpoint at the entrance to the Lachin corridor, the only road linking Armenia to the separatist region.
- The move followed a months-long roadblock by Azerbaijani environmental activists, which Yerevan claims has led to a humanitarian crisis in the mountainous enclave that had experienced shortages of food and fuel.
- Azerbaijan insisted civilian transport was running unimpeded through the Lachin corridor.
- Armenian said that the "humanitarian situation in Karabakh has extremely worsened" after Baku blocked the traffic through the road.
- Baku's actions prove that Azerbaijan is pursuing a policy of ethnic cleansing in Karabakh.
- Earlier International Court of Justice (ICJ) -- the UN's top judicial body -- ordered Azerbaijan to ensure free movement on the road.
- Armenia called on the ICJ to order Azerbaijan to end the blockade of the Lachin road altogether.
- The two former Soviet republics have been at loggerheads for more than 30 years and fought two wars for the control of Karabakh -- in the 1990s and 2020.
- Six weeks of fighting in autumn 2020 ended with a Russian-sponsored ceasefire that saw Armenia cede swathes of territories it had controlled for decades.
- There have been frequent clashes at their shared border despite the ongoing peace talks between Baku and Yerevan under the mediation from the European Union and United States.
- When the Soviet Union collapsed in 1991, ethnic Armenian separatists in Karabakh broke away from Azerbaijan. The ensuing conflict claimed some 30,000 lives.

## Nagorno-Karabakh

- Nagorno-Karabakh, known as Artsakh by Armenians, is a landlocked mountainous area in South Caucasus.
- It was claimed by both Azerbaijan and Armenia after the fall of Russian Empire in 1917 and has remained a point of tension ever since.
- Territory is internationally recognised as part of oil-rich Azerbaijan, but its inhabitants are predominantly ethnic Armenians.



## Global Fund for EV battery

### Why in News

G20 policy paper moots global fund for EV battery mineral recycling capacity

### Important Points

- A policy brief submitted to Task Force-4 (TF-4) of the G20 has recommended the creation of a global fund to invest in increasing recycling capacities for lithium-ion batteries used in electric vehicles (EVs).
- The paper, titled Building a resilient EV battery value chain, also suggested the creation of a separate fund to invest in battery recycling technologies.
- The paper noted that battery recycling is at a nascent stage with gaps concerning technology in reducing recycling cost and improving material recovery capacity.
- It favours a comprehensive approach for recycling end of life EV batteries to meet rising demand for minerals such as lithium, cobalt, nickel and graphite.
- The recycling industry alone could create a \$6bn profit pool by 2040, with revenue potentially exceeding \$40bn, a three-fold increase from 2030 values.
- However, critics often point out that the emission benefits are often overstated as battery management challenges are ignored.
- The cumulative potential of lithium-ion batteries in India from 2022–30 across all segments is estimated to be around 600 GWh (base case).
- Battery waste management Act 2022 confers the Producers (including importers) the obligation of Extended Producer Responsibility (EPR) for the battery that they introduce in the market to ensure its collection and recycling.
- Challenges in Recycling: High Capital Cost, Non-Eco Friendly in nature, Requires high temperature and sophisticated machinery, lack of digital identifiers for batteries

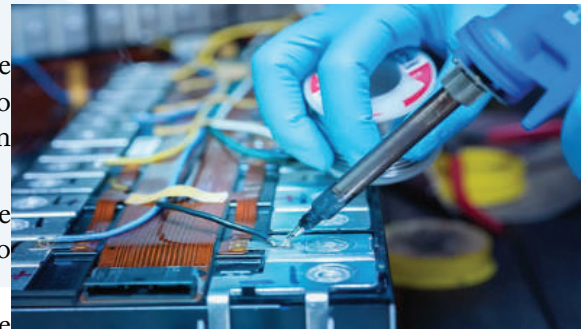

## India and US

### Why in News

India, US agree on roadmap for defence industry cooperation

### Important Points

- India and the United States have concluded a roadmap for defence industry cooperation for the next few years, the Indian government says – a move expected to bolster New Delhi's defence manufacturing ambitions.
- Washington is working to deepen ties with the world's largest arms importer and sees deeper military-to-military and technology ties with the South Asian country as a key counterweight to China's dominance in the region.
- The roadmap was finalised at a meeting between visiting US Defense Secretary and Indian Defence Minister in New Delhi.
- Both sides will identify opportunities for co-development of new technologies and co-production of existing and new systems and facilitate increased collaboration between defence start-up ecosystems of the two countries.

- Towards these objectives, they concluded a roadmap for US-India Defence Industrial Cooperation which shall guide the policy direction for the next few years.
- India depends on Russia for nearly half its military supplies but has also increasingly diversified its sources to buy from the US, France and Israel among other nations.
- New Delhi also wants global defence manufacturers to partner with Indian companies and produce arms and military equipment in India for local consumption as well as exports.
- India is looking to buy 18 high-altitude, long-endurance armed drones from General Atomics Aeronautical Systems Inc for an estimated \$1.5bn to \$2bn.
- The aircraft would likely be deployed along its restive borders with China and Pakistan and in the strategic Indian Ocean region.
- US defence trade with India has risen from near zero in 2008 to more than \$20bn in 2020. Indian purchases from the US have included long-range maritime patrol aircraft, C-130 transport aircraft, missiles and drones.



## Iran

### Why in News

Iran unveils what it calls a hypersonic missile able to beat air defenses amid tensions with US

### Important Points

- Iran claimed that it had created a hypersonic missile capable of travelling at 15 times the speed of sound.
- The announcement comes as tensions remain high with the United States over Tehran's nuclear program.
- Iran reported that the missile — called Fattah, or “Conqueror” in Farsi — had a range of up to 1,400 kilometers.
- The report also claimed the missile could pass through any regional missile defense system, though it offered no evidence to support the claim.
- China is believed to be pursuing the weapons, as is America. Russia claims to already be fielding the weapons and has said it used them on the battlefield in Ukraine.

### What are hypersonic weapons?

- Hypersonic weapons, which fly at speeds in excess of Mach 5, or five times the speed of sound, could pose crucial challenges to missile defense systems because of their speed and manoeuvrability.
- They are different from ballistic missiles, which can also travel at hypersonic speeds (of at least Mach 5) but have set trajectories and limited maneuverability.

**What Are Hypersonic Weapons?**  
Multiple countries are talking about efforts to develop hypersonic weapons, describing them as “game changers.” But what are these weapons? Who has them? And just how revolutionary are they?

**What are hypersonic weapons?**  
Hypersonic weapons fly at speeds of at least Mach 5 and are highly maneuverable and able to change course during flight. They are different from ballistic missiles, which can also travel at hypersonic speeds (of at least Mach 5 but have set trajectories and limited maneuverability).

**How are hypersonic weapons different from ballistic missiles?**  
Ballistic missiles can also travel at hypersonic speeds of at least Mach 5, but they have set trajectories and limited maneuverability.

**What are the different kinds of hypersonic weapons?**  
**Hypersonic glide vehicles** are launched from a rocket. The glide vehicle then separates from the rocket and “glides” at speeds of at least Mach 5 toward a target.  
**Hypersonic cruise missiles** are powered by high-speed, air breathing engines.

**What is their significance?**  
The ability to launch highly maneuverable weapons at hypersonic speeds gives any country a considerable advantage, because such weapons can evade just about any defense system currently in use.  
U.S. officials have said that while there are some ground-based radars that can detect hypersonic weapons, there are not enough to give adequate warning of an attack. Officials have advocated the construction of a space-based radar system.



### What are the different kinds of hypersonic weapons?

- There are two main categories of hypersonic weapons: hypersonic glide vehicles and hypersonic cruise missiles.
- Hypersonic glide vehicles are launched from a rocket. The glide vehicle then separates from the rocket and “glides” at speeds of at least Mach 5 toward a target.
- Hypersonic cruise missiles are powered by high-speed, air-breathing engines.

### What is their significance?

- The ability to launch highly maneuverable weapons at hypersonic speeds gives any country a considerable advantage, because such weapons can evade just about any defense system currently in use.

### How are hypersonic weapons different from ballistic missiles?

- Ballistic missiles can also travel at hypersonic speeds of at least Mach 5, but they have set trajectories and limited maneuverability.

#### Hypersonic weapons

Considered the next generation of arms with conventional or nuclear warheads that are hard to detect and can travel more than five times the speed of sound

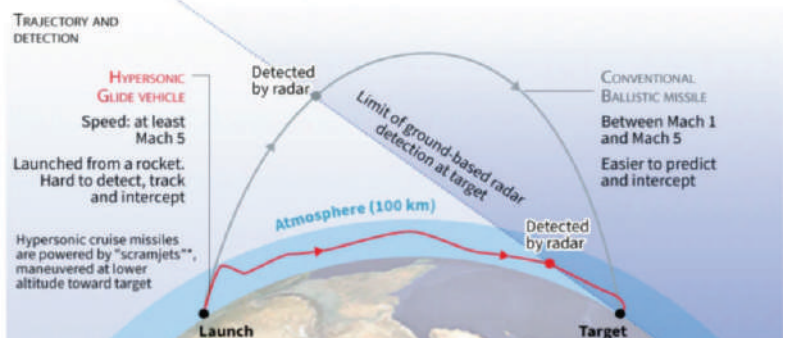

### What countries are developing hypersonic weapons?

- The United States, Russia and China are all developing hypersonic weapons.
- Additional countries are conducting research on weapons, while others have made claims about testing hypersonic weapons that cannot yet be verified.

## India and Suriname

### Why in News

150th anniversary of arrival of Indians in Suriname

### Important Points

- Recently the Indian President has been conferred with the ‘Grand Order of the Chain of the Yellow Star’, the highest civilian honor of Suriname.
- Also, India has also expanded the eligibility criteria for OCI card to Indian expatriates living in Suriname.
- It has been decided to increase the eligibility criteria of Indian expatriates living there from 4th generation to 6th.

### Indian community in Suriname

- On June 5, 1873, the first group of Indians reached the sea coast of Suriname aboard a ship named Lalla Rukh.
- Indo-Surinamese is the largest ethnic community in the country. They have 27.4 percent share in the total population here.
- In the period 1873–1916, over 34,000 Indians were brought to Suriname from British India as indentured laborers to work on the plantations.
- In the 19th century, a severe famine in the Gangetic plains led to extreme poverty. Therefore, due to poverty and scarcity, the Indian laborers were forced to migrate.
- In Suriname the descendants of these workers mainly speak the surname Hindustani language. It is a language derived from the mixture of Awadhi and Bhojpuri. It is the third most spoken language in Suriname.
- India and Suriname began their relations in 1976 after Suriname gained independence.



## Suriname

- The capital of Suriname is Paramaribo. It is located on the northeast coast of South America.
- Neighboring Countries: It is surrounded by French Guiana in the east, Brazil in the south and Guyana in the west.
- Geographical features: Narrow coastal plain with mostly hilly areas and marshy areas.
- Major rivers: Commewine River, Copenem River, Corentin River, Marowine (Moroni) River etc.
- Highest peak: Juliana Top.

## Northern Sea Route

### Why in News

Russia to invest \$24bn to develop Northern Sea Route

### Important Points

- Russia has unveiled plans to invest 2 trillion rubles (\$24 billion) in the development of its Northern Sea Route (NSR) over the next 13 years, and a draft law prepared by the government has already passed the first reading in the State Duma.

### About Northern Sea Route (NSR):

- The Northern Sea Route (NSR), or the Northeast Passage (NEP), connects the eastern and western parts of the Arctic Ocean.
- The NSR runs from the Barents Sea, near Russia's border with Norway, to the Bering Strait between Siberia and Alaska.
- NSR is different from the Northwest Passage which is a series of possible shipping routes connecting the Atlantic and Pacific Oceans through the Canadian Arctic.
- The entire route lies in Arctic waters and within Russia's exclusive economic zone. It is one-third of the distance of the traditional route through the Suez Canal.
- Due to Climate Change, NSR in Russia is becoming more accessible. Usually the route only opens for two months annually.
- The NSR route between Europe and Asia is just 13,000 km long, compared to the 21,000 km covered by the Suez Canal route, which reduces the travel duration from one month to less than two weeks.
- The whole path, which has been dubbed the Northeast Passage and is comparable to Canada's Northwest Passage, is located in the Arctic seas and within Russia's Exclusive Economic Zone (EEZ).

### The NSR is economically profitable in comparison with the Suez Canal due to several reasons:

- Energy and time savings compared to the normally used route via Suez Canal are about 30-40%.
- It is one-third of the distance of the traditional route through the Suez Canal.
- Easier to explore, exploit and transport natural resources of the region.
- There is no risk of a pirate attack which the Horn of Africa is notorious for.

### Advantages

- Become a global energy superhighway for the exchange of various natural resources from the Russian Arctic, including hydrocarbons;
- Create strong supply networks to the Arctic Zone of the Russian Federation (AZRF) to guarantee the uninterrupted flow of cargo to the ports and new points of economic growth;
- Gain prominence in the passage of international trade.

### Challenges:

- Russia exercising its sovereignty over NSR and denial of the principle of freedom of navigation might lead to geo-strategic conflict.
- Arctic fog will reduce sailing time.
- Environmental risks and increased operating costs.



## India and New Zealand

### Why in News

First Round Table Joint Meeting between India and New Zealand was held in Delhi

### Important Points

- India and New Zealand held their first Round Table Joint Meeting with industries from both nations present in New Delhi.
- The meeting was co-chaired by the additional secretary, Department of Commerce, Government of India and the High Commissioner of New Zealand in India.
- During the meeting, both sides acknowledged the current level of bilateral commerce and emphasised on the enormous potential of the India-New Zealand alliance and the need for further economic cooperation in areas of mutual interest.
- The discussions also focused on the extension of the objectives set by the Joint Trade Committee (JTC), formed under the Bilateral Trade Agreement of 1986.
- The New Zealand High Commissioner emphasized the importance of joint efforts while keeping in mind the principles of mutual benefit, proportionality, enabling trade, and collaboration with private sectors.
- Pine put forth the areas that can be explored together by India and New Zealand.
- These include the promotion of a Unified Payment Interface (UPI) system, carbon credit cooperation, economic cooperation through sectoral arrangements and working together on specific issues like the comprehensive proposal made by Zespri and prioritization of requests on non-tariff measures for bilateral gains to the businesses of both the sides.
- A report by New Zealand Business Council called 'India New Zealand -Relationship ready for next phase' was also unveiled at this meeting.
- The report mentions all the feasible areas of cooperative activities for economic prosperity.
- The need for a proactive operational framework for mutual benefit by creating working groups which would feed to the Joint Trade Committee with concrete ideas and the solution thereof.



## Atlantic Declaration

### Why in New

US, UK forged 'Atlantic Declaration' with an aim to counter Russia, China and economic instability.

### Important Points

- The United States and Britain announced a new strategic pact to strengthen the “special relationship” between the two countries.
- The pact aims to counter the threats posed by Russia, China, and economic instability.
- US President and UK Prime Minister discussed key issues such as Russia’s invasion of Ukraine and the impact of artificial intelligence.

### Atlantic Declaration:

- The leaders adopted an “Atlantic Declaration” to enhance industry ties in defense and renewable energy.
- The declaration acknowledges the challenges to international stability posed by authoritarian states, disruptive technologies, non-state actors, and transnational issues like climate change.
- The goal is to boost cooperation between the US and UK to tackle these challenges effectively.

### Green Economy:

- The UK’s ambition for a post-Brexit free-trade agreement with the US was not achieved during the summit.
- Instead, both leaders agreed to focus on crafting a new green economy through significant industrial subsidies.
- This aligns with USA plan, and UK settled for supporting the US approach.



### World Economy and Artificial Intelligence:

- USA and UK recognized that the world economy is undergoing significant changes, comparable to the Industrial Revolution.
- The evolution of artificial intelligence was a major topic of discussion.
- The leaders acknowledged the need for governments to coordinate their responses to the potential risks associated with AI.

### World's First AI Summit in the UK:

- UK revealed plans to host the world's first AI summit in the UK later in the year.
- USA expressed his support for convening “likeminded” countries for the summit.
- UK also proposed the UK hosting a future AI regulator.

### Challenges and Regulation of AI:

- Industry figures have been advocating for regulation of AI, and the US and EU are already engaged in their own dialogue on an AI code of conduct.
- UK faces challenges in pursuing his AI ambitions, as existing discussions and interests may affect the implementation of his plans.
- However, UK expressed confidence in the strength of the US-UK partnership and emphasized shared values.

### Addressing Energy Market Instability and Ukraine War:

- The Atlantic Declaration is expected to help the allies address the chronic instability in energy markets caused by Russia's actions.
- The leaders have not yet placed blame on Moscow for the recent destruction of a dam in Ukraine, but the UK has promised aid relief to the victims.
- The Ukraine war serves as a catalyst for emphasizing the need for transatlantic economic alignment.

## Developing Nation Status Act

### Why in News

US Senate committee approved legislation to remove China's “Developing Country” status

### Important Points

- The US Senate Foreign Relations Committee has recently approved bipartisan legislation known as the Developing Nation Status Act, which seeks to remove China's “developing country” status.
- This move follows a similar action taken by the US House of Representatives earlier.
- The legislation has significant implications for China's position in international organizations and treaties.

### The Developing Nation Status Act

- The legislation, officially called the Developing Nation Status Act, was unanimously passed by the US Senate Foreign Relations Committee.
- Its main goal is to constitute a US policy against granting China the “developing country” status in future treaties and international organizations.
- The act directs the Secretary of State to actively pursue changing China's status to that of a “developed country” in relevant agreements.

### Privileges and Exploitation

- Receive preferential treatment in terms of market access, loans, reduction in government support and technical assistance from international organisations.
- Longer transition period before they are required to fully implement WTO agreement.
- Benefit from unilateral preference schemes of some of developed country members such as USA's Generalized System of Preferences (GSP).
- Favourable treatment concerning issues such as climate change responsibilities.
- China's developing country status currently affords it certain privileges within specific organizations and treaties. Supporters of the legislation argue that China can no longer be considered a developing country due to its robust economy, military power, and extensive global investments.
- They contend that China has exploited its designation for an unfair advantage in multilateral negotiations, particularly evident in its Belt and Road Initiative.

### International Organizations and Responses

- World Trade Organization (WTO) has not defined ‘developed’ and ‘developing’ countries and therefore member countries are free to announce whether they are ‘developed’ or ‘developing’.

## Bangkok Vision 2030

### Why in News

According to the Secretary (East) in the Ministry of External Affairs (MEA), The Bay of Bengal Initiative for Multi-Sectoral Technical and Economic Cooperation (BIMSTEC) summit end of this year will adopt a Bangkok Vision 2030.

### Important Points

#### Bangkok Vision 2030

- In March 2023, Thailand hosted the 19th BIMSTEC ministerial meeting.
- It discussed and approved the draft text of BIMSTEC Bangkok Vision 2030, a leader-level document proposed by Thailand to guide BIMSTEC towards a prosperous, resilient, and open region by 2030.
- The document aims to further promote BIMSTEC as a region of peace, stability, and economic sustainability.
- The goals found in the vision are also in line with the United Nations' Sustainable Development Goals and Thailand's bio-circular-green economic model.
- This document will serve as an overarching framework, providing direction to the organization and its activities.
- Thailand has put forth the Bangkok vision 2030 which seeks to propel BIMSTEC towards a region that is prosperous, resilient and open.

#### About BIMSTEC

- BIMSTEC is a regional organization consisting of seven member states surrounding the Bay of Bengal.
- It aims to promote technical and economic cooperation among its member countries.

#### Member States:

- BIMSTEC comprises Bangladesh, Bhutan, India, Myanmar, Nepal, Sri Lanka, and Thailand.
- The member states are strategically located in the Bay of Bengal region.

#### Objectives:

- Foster economic cooperation: BIMSTEC aims to enhance trade, investment, and economic integration among member countries.
- Strengthen connectivity: The organization seeks to improve physical, economic, and digital connectivity within the region.
- Promote people-to-people contact: BIMSTEC aims to facilitate cultural and educational exchanges, tourism, and cooperation in various sectors.
- Address common challenges: It seeks to address common challenges such as poverty, climate change, natural disasters, and terrorism.

#### Areas of Cooperation:

##### 1. Trade and Investment:

- Enhancing trade facilitation, reducing barriers, and promoting intra-regional trade.
- Encouraging investment and creating a conducive business environment.

##### 2. Transport and Connectivity:

- Improving physical connectivity through the development of transport infrastructure and networks.
- Enhancing maritime connectivity, air links, and multimodal transport within the region.

##### 3. Energy:

- Promoting cooperation in the field of energy, including renewable energy sources and efficient energy use.
- Facilitating energy trade and collaboration on energy security.

##### 4. Tourism and Culture:

- Encouraging collaboration in tourism promotion, cultural exchanges, and preservation of heritage sites.
- Facilitating tourism flows and creating a favorable environment for the tourism industry.

##### 5. Agriculture and Food Security:

- Promoting cooperation in agriculture, fisheries, and food security.
- Sharing best practices, technology, and knowledge for sustainable agricultural development.

##### 6. Environment and Climate Change:

- Addressing environmental challenges and promoting sustainable development practices.
- Collaborating on climate change mitigation and adaptation measures.

## NATO Plus grouping

### Why in News

An American Senator has said he plans to introduce a bill to make India part of the NATO Plus grouping.

### Important Points

- Amid the growing challenges posed by a rising China, a US Senator plans to introduce a bill that would make India a part of the NATO Plus grouping.
- This move would facilitate the transfer of topmost American technology and defence equipment without much bureaucratic hassle.
- The NATO Plus security arrangement currently includes NATO and five aligned nations — Australia, New Zealand, Japan, Israel, and South Korea. Its purpose is to boost defence and intelligence ties.
- The aim of this effort is to upgrade India-US defence ties. However, India had earlier already rejected the framework.
- India's inclusion in this category will strengthen their defence ties, especially as they both face challenges related to China.
- The Quad is a great step forward in that area. India on defence alignment to the NATO plus five would be the next step.

### About NATO

- The North Atlantic Treaty Organization (NATO) was founded in 1949 and is a group of 31 countries from Europe and North America that exists to protect the people and territory of its members.
- The Alliance is founded on the principle of collective defence, meaning that if one NATO Ally is attacked, then all NATO Allies are attacked. For example, when terrorists attacked the United States on 9/11 2001, all NATO Allies stood with America as though they had also been attacked.
- NATO plays an important role in fighting terrorism.
- Through NATO Mission Iraq, we are advising and assisting Iraqi security forces and institutions to stabilise their country, fight terrorism and prevent the return of Daesh.
- NATO is also a full member of the Global Coalition to Defeat ISIS, and our AWACS surveillance aircraft have played an important supporting role.
- For nearly 20 years, NATO helped to ensure Afghanistan did not become a safe haven for international terrorists.
- In Naples, NATO has set up a 'Hub for the South' to help Allies tackle the threat of terrorism.
- The Open Door Policy is a founding principle of NATO. This means that any country in Europe is free to join NATO if it is prepared to meet the standards and obligations of membership, contributes to the security of the Alliance, and shares NATO's values of freedom, democracy and the rule of law.
- Since 1949, NATO's membership has grown from 12 to 31 countries.
- In April 2023, we welcomed Finland as our 31st member.

### About Quad

- It is the grouping of four democracies –India, Australia, the US, and Japan.
- All four nations find a common ground of being democratic nations and also support the common interest of unhindered maritime trade and security.
- It aims to ensure and support a “free, open and prosperous” Indo-Pacific region.
- The idea of Quad was first mooted by Japanese Prime Minister Shinzo Abe in 2007. However, the idea couldn't move ahead with Australia pulling out of it, apparently due to Chinese pressure.
- Finally in 2017, India, Australia, the US and Japan, came together and formed this “quadrilateral” coalition.

## Heliopolis Memorial

### Why in News

India will pay his respects at the Heliopolis (Port Tewfik) Memorial in the Heliopolis War Cemetery in Cairo, Egypt.

### Important Points

- PM of India will pay his respects at the Heliopolis (Port Tewfik) Memorial in the Heliopolis War Cemetery in Cairo, Egypt.



- Here the names of nearly 4,000 Indian soldiers who fought in World War 1 in Egypt and Palestine are commemorated.

#### About Heliopolis Memorial:

- It is part of the larger Heliopolis Commonwealth War Graves Cemetery.
- This memorial commemorates the memory of 3,727 Indian soldiers who died fighting in various campaigns in Egypt and Palestine in the First World War.
- The original Port Tewfik memorial was unveiled in 1926 and was situated at the entrance to the Suez Canal.
- The memorial was destroyed in the Israeli-Egyptian War of 1967 by retreating Egyptian soldiers, and a new memorial was erected in Heliopolis Commonwealth War Grave Cemetery in 1980.
- The Indian troops played a key role in securing the Suez Canal in Egypt and in Palestine, where Indian cavalry participated in the Battle of Haifa and also played a key role in Mesopotamia in the First World War.
- Port Tewfik is now known as Port Suez.



#### About Port Suez

- It is located in Egypt along the northern coastline of the Gulf of Suez.
- The port and city mark the southern terminus of the Suez Canal, which runs north-south through Egypt from the Mediterranean Sea to the Gulf of Suez.
- The port serves vessels transporting general cargo, oil tankers, and both commercial and private passenger vessels.

#### Role of the Indian Army in West Asia during World War 1

- Significance of Indian Troops: Indian troops played a major role in securing the Suez Canal in Egypt and participating in campaigns in Palestine and Mesopotamia.
- Battle of Haifa: Indian cavalry's participation in the Battle of Haifa, commemorated by a war memorial in New Delhi.
- Diverse Representation: The memorial commemorates numerous Indian regiments from the Indian Army and State Forces of princely states.
- Princely States' Contribution: Troops from princely states actively participated in various theatres of the war effort during World War 1.

## Artemis Accords

### Why in News

India-US signs Artemis Accords, ISRO-NASA to launch joint space mission in 2024.

### Important Points

#### What are Artemis Accords?

- The Artemis Accords, built upon the foundation of the Outer Space Treaty of 1967 (OST), constitute a comprehensive framework of guidelines that aim to govern the exploration and utilization of space in the modern era.
- While not legally binding, these principles serve as a roadmap for international collaboration in civil space endeavors.
- Spearheaded by the United States, the Artemis Accords endeavor to facilitate the human return to the moon by 2025, as a pivotal step towards advancing space exploration to encompass Mars and other celestial destinations in the future.
- The White House added that both NASA and ISRO have agreed on a joint space mission in 2024.
- Principles of Artemis Accord: Use of space for peaceful purposes, transparency, interoperability, Registration of Space objects, Preserving space heritage, De-confliction of space, managing space debris.

#### Semiconductors

- Indian and US companies will partner to build an ecosystem for semiconductors that promotes supply chain diversification.

- Micron Technology, in partnership with the Indian National Semiconductor Mission, has revealed plans for a significant investment exceeding USD 800 million.
- This substantial financial commitment, coupled with additional funding from Indian authorities, will culminate in the establishment of a state-of-the-art semiconductor assembly and test facility in India, with a total investment amounting to USD 2.75 billion.

### Technology

- India and US have signed an agreement on AI and quantum technologies.
- The Indian Quantum universities and entities are welcome to work with Economic Development Consortium of the United States.
- The countries are also working together in advanced telecommunication including 5G and 6G technologies. India and US are also working together on Open Radio Access Network (RAN) systems.

### Significance of move

- Both countries will share data, technology, and resources, and work together to ensure safety and sustainability of lunar exploration.
- Help in strengthening the curriculum, facilities, and training designs for Gaganyaan mission.
- India's space companies could become part of a global supply chain.

## Order of the Nile award

### Why in News

Recently, the Egyptian President conferred the country's highest state honour "Order of the Nile" award to the Prime Minister of India.

### Important Points

- Indian PM was on two-day visit to Egypt at the invitation of the Egyptian President.
- The visit, the first by any Indian PM since 1997, is of significance as Egypt has traditionally been one of India's most important trading partners in the African continent.
- India-Egypt Bilateral Trade Agreement has been in operation since March 1978 and is based on the Most Favored Nation clause, according to the Egyptian Central Agency for Public Mobilization and Statistics (CAPMAS).
- India was Egypt's fifth largest trading partner in the period April 2022-Dec 2022.
- It was the 11th-largest importer of Egyptian goods and the 5th-largest exporter to Egypt during the same time.
- The two countries share a close political understanding based on a long history of contact and cooperation in bilateral, regional and global issues.



### About the Order of the Nile Award:

- It is Egypt's highest state honour.
- Instituted in 1915, the 'Order of the Nile' is conferred upon Heads of state, Crown Princes, and Vice-Presidents who offer Egypt or humanity invaluable services.
- The 'Order of the Nile' is a pure gold collar consisting of three-square gold units comprising Pharaonic symbols.
- The first unit resembles the idea of protecting the state against evils, the second one resembles prosperity and happiness brought by the Nile, and the third one refers to wealth and endurance.
- The three units are connected by a circular gold flower decorated with turquoise and ruby.
- Hanging from the collar is a hexagonal pendant decorated with flowers of the Pharaonic style and turquoise and ruby gems.
- In the middle of the pendant, there is a protruding symbol representing the Nile that brings together the North (represented by the Papyrus) and the South (represented by the Lotus).
- Those who receive the 'Order of the Nile' shall be saluted upon their death.

## World's Largest Grain Storage Plan in Cooperative Sector

### Why in News

Cabinet approves Constitution and Empowerment of an Inter-Ministerial Committee (IMC) for Facilitation of “World's Largest Grain Storage Plan in Cooperative Sector”.

### Important Points

- The Union Cabinet approved the constitution and empowerment of an Inter Ministerial Committee (IMC) for facilitation of the “World's Largest Grain Storage Plan in Cooperative Sector” by convergence of various schemes of the Ministry of Agriculture and Farmers Welfare, Ministry of Consumer Affairs, Food and Public Distribution and Ministry of Food Processing Industries.
- In order to ensure time bound and uniform implementation of the Plan in a professional manner, Ministry of Cooperation will implement a pilot project in at least 10 selected Districts of different States/ UTs in the country.
- The Pilot would provide valuable insights into the various regional requirements of the project, the learnings from which will be suitably incorporated for the country-wide implementation of the Plan.



### Implementation

- An Inter-Ministerial Committee (IMC) will be constituted under the Chairmanship of Minister of Cooperation, with Minister of Agriculture and Farmers Welfare, Minister of Consumer Affairs, Food and Public Distribution, Minister of Food Processing Industries and Secretaries concerned as members to modify guidelines/ implementation methodologies of the schemes of the respective Ministries as and when need arises, within the approved outlays and prescribed goals, for facilitation of the ‘World's Largest Grain Storage Plan in Cooperative Sector’ by creation of infrastructure such as godowns, etc. for Agriculture and Allied purposes, at selected ‘viable’ Primary Agricultural Credit Societies (PACS).
- The Plan would be implemented by utilizing the available outlays provided under the identified schemes of the respective Ministries.

### Following schemes have been identified for convergence under the Plan:

- (a) Ministry of Agriculture and Farmers Welfare:
  - Agriculture Infrastructure Fund (AIF),
  - Agricultural Marketing Infrastructure Scheme (AMI),
  - Mission for Integrated Development of Horticulture (MIDH),
  - Sub Mission on Agricultural Mechanization (SMAM)
- (b) Ministry of Food Processing Industries:
  - Pradhan Mantri Formalization of Micro Food Processing Enterprises Scheme (PMFME),
  - Pradhan Mantri Kisan Sampada Yojana (PMKSY)
- (c) Ministry of Consumer Affairs, Food and Public Distribution:
  - Allocation of food grains under the National Food Security Act,
  - Procurement operations at Minimum Support Price

### Benefits of the Plan

- The plan is multi-pronged – it aims to address not just the shortage of agricultural storage infrastructure in the country by facilitating establishment of godowns at the level of PACS, but would also enable PACS to undertake various other activities, viz:



- Functioning as Procurement centres for State Agencies/ Food Corporation of India (FCI);
- Serving as Fair Price Shops (FPS);
- Setting up custom hiring centers;
- Setting up common processing units, including assaying, sorting, grading units for agricultural produce, etc.
- Further, creation of decentralized storage capacity at the local level would reduce food grain wastage and strengthening food security of the country.
- By providing various options to the farmers, it would prevent distress sale of crops, thus enabling the farmers to realise better prices for their produce.
- It would hugely reduce the cost incurred in transportation of food grains to procurement centres and again transporting the stocks back from warehouses to FPS.
- Through ‘whole-of-Government’ approach, the Plan would strengthen PACS by enabling them to diversify their business activities, thus enhancing the incomes of the farmer members as well.

#### **Time-frame and manner of implementation**

- National Level Coordination Committee will be formed within one week of the Cabinet approval.
- Implementation guidelines will be issued within 15 days of the Cabinet approval.
- A portal for the linkage of PACS with Govt. of India and State Governments will be rolled out within 45 days of the Cabinet approval.
- Implementation of proposal will start within 45 days of the Cabinet approval.

#### **Background**

- The Prime Minister of India has observed that all out efforts should be made to leverage the strength of the cooperatives and transform them into successful and vibrant business enterprises to realize the vision of “Sahakar-se-Samridhi”.
- To take this vision forward, the Ministry of Cooperation has brought out the ‘World’s Largest Grain Storage Plan in Cooperative Sector’. The plan entails setting up various types of agri-infrastructure, including warehouse, custom hiring center, processing units, etc. at the level of PACS, thus transforming them into multipurpose societies.
- Creation and modernization of infrastructure at the level of PACS will reduce food grain wastage by creating sufficient storage capacity, strengthen food security of the country and enable farmers to realise better prices for their crops.
- There are more than 1,00,000 Primary Agricultural Credit Societies (PACS) in the country with a huge member base of more than 13 crore farmers.
- In view of the important role played by PACS at the grass root level in transforming the agricultural and rural landscape of Indian economy and to leverage their deep reach up to the last mile, this initiative has been undertaken to set up decentralized storage capacity at the level of PACS along with other agri infrastructure, which would not only strengthen the food security of the country, but would also enable PACS to transform themselves into vibrant economic entities.

## **CITIIS 2.0**

### **Why in News**

Cabinet approves City Investments to Innovate, Integrate and Sustain 2.0 (CITIIS 2.0) from 2023 to 2027

### **Important Points**

- The Union Cabinet chaired by the Hon'ble Prime Minister Shri Narendra Modi, has approved the City Investments to Innovate, Integrate and Sustain 2.0 (CITIIS 2.0).
- CITIIS 2.0 is a program conceived by the Ministry of Housing and Urban Affairs (MoHUA) in partnership with the French Development Agency (AFD), Kreditanstalt für Wiederaufbau (KfW), the European Union (EU), and National Institute of Urban Affairs (NIUA). The program will run for a period of four years, i.e., from 2023 till 2027.
- The program envisages to support competitively selected projects promoting circular economy with focus on integrated waste management at the city level, climate-oriented reform actions at the State level, and institutional strengthening and knowledge dissemination at the National level.
- The funding for CITIIS 2.0 would include a loan of Rs.1760 crore (EUR 200 million) from AFD and KfW (EUR 100 million each) and a technical assistance grant of Rs.106 cr. (EUR 12 million) from the EU.

- CITIIS 2.0 aims to leverage and scale up the learnings and successes of CITIIS 1.0. CITIIS 1.0 was launched jointly in 2018 by MoHUA, AFD, EU, and NIUA, with a total outlay of ₹933 crore (EUR 106 million). CITIIS 1.0 consisted of three components:
  - Component 1: 12 city-level projects selected through a competitive process.
  - Component 2: Capacity-development activities in the State of Odisha.
  - Component 3: Promoting integrated urban management at the national level through activities undertaken by NIUA, which was the Program Management Unit (PMU) for CITIIS 1.0
- Technical assistance was made available under the program at all three levels through domestic experts, international experts, and transversal experts.
- It has resulted in the mainstreaming of innovative, integrated and sustainable urban development practices through a unique challenge-driven financing model based on the principles of competitive and cooperative federalism.

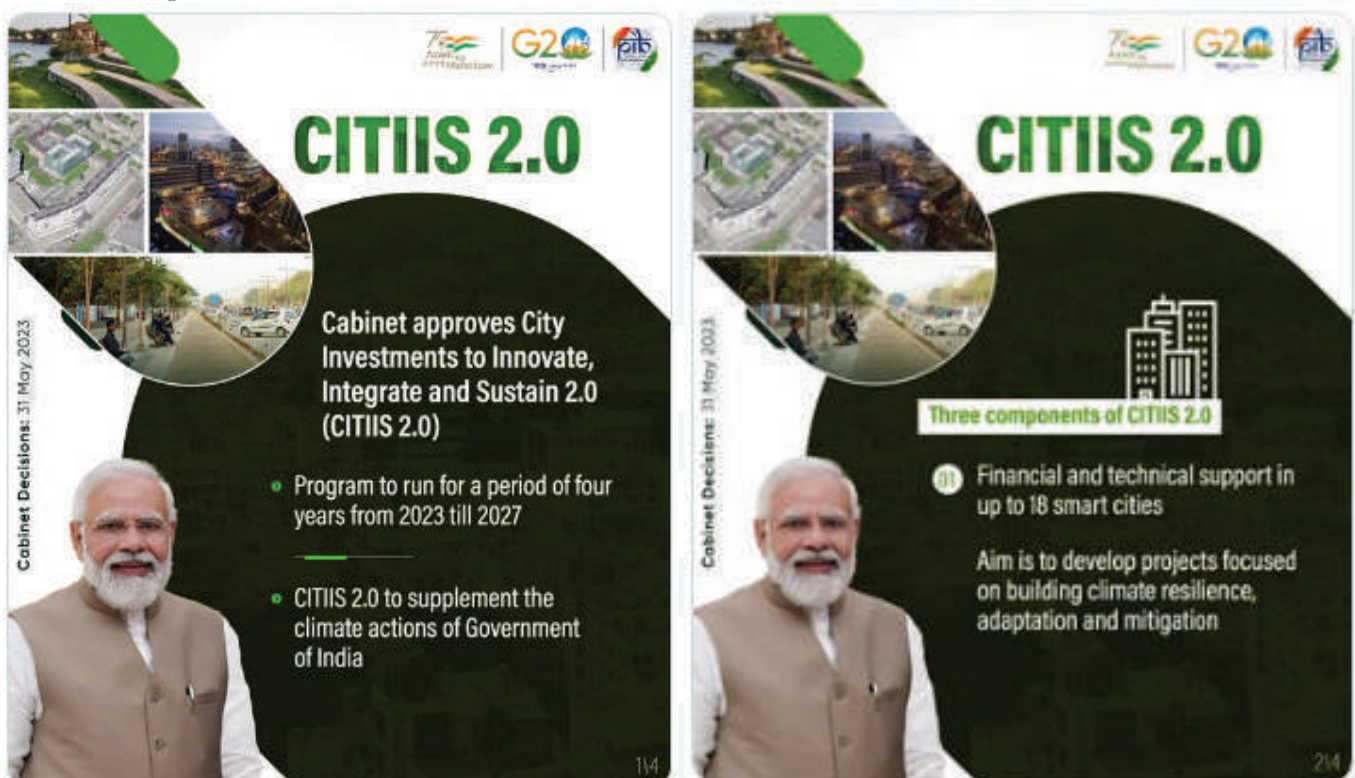

**Following the CITIIS 1.0 model, CITIIS 2.0 has three major components:**

- Component 1: Financial and technical support for developing projects focused on building climate resilience, adaptation and mitigation in up to 18 smart cities through selection of competitively selected projects promoting circular economy with focus on integrated waste management.
- Component 2: All States and UTs will be eligible for support on demand basis. The States will be provided support to (a) set-up/strengthen their existing State climate centres/ Climate cells/ equivalents (b) create State and city level Climate Data Observatories (c) facilitate climate-data driven planning, develop climate action plans and (d) build capacities of municipal functionaries. To achieve these objectives, the PMU at NIUA will coordinate provision of technical assistance and strategic support to State Governments.
- Component 3: Interventions at all three levels; Centre, State and City to further climate governance in urban India through institutional strengthening, knowledge dissemination, partnerships, building capacity, research and development to support scale up across all States and Cities.
- CITIIS 2.0 will supplement the climate actions of Government of India through its ongoing National programs (National Mission on Sustainable Habitat, AMRUT 2.0, Swachh Bharat Mission 2.0 and Smart Cities Mission), as well as contributing positively to India's Intended Nationally Determined Contributions (INDCs) and Conference of the Parties (COP26) commitments.

## Dugdh Sankalan Sathi Mobile App

### Why in News

Union Ministry of Heavy Industries Launches “Dugdh Sankalan Sathi Mobile App” to Transform Indian Dairy Industries.

### Important Points

- This innovative application, designed and developed by Rajasthan Electronics & Instruments Limited (REIL), Jaipur, a “Mini Ratna” Central Public Sector Enterprises under the Ministry of Heavy Industries, is poised to make a lasting impact on the Indian Dairy Industries by addressing key challenges in the milk collection process.
- This mobile app aims to improve the quality of milk, foster transparency among stakeholders, and streamline operations at the grassroots village level, including Milk Cooperative Societies.
- Through this App Ministry of Heavy Industry has taken a revolutionary step towards realizing the commitment of Government of India to digitize the process and facilitate Direct Beneficiary Transfer to milk producers.
- Dugdh Sankalan Sathi Mobile App’ will bring transparency, efficiency, and empowerment to all stakeholders involved in the milk collection process, ultimately benefiting the milk producers and contributing to the growth of the dairy sector.
- The application will be contextually active in the field to improve operations at the grassroots level across all partnerships including milk producers, milk co-operative societies, milk organizations and state federations.
- Milk Collection Partner Mobile App will inform all services to milk producers in English, Hindi, Punjabi, Telugu and other languages
- Recognizing the critical need for advancements in the dairy industry, REIL has developed a comprehensive cloud-based solution that leverages the latest state-of-the-art platform.
- This forward-thinking initiative reflects the Government of India’s commitment for digitizing processes and facilitating direct beneficiary transfers of the government subsidies to milk producers.
- The “Dugdh Sankalan Sathi Mobile App” will bring significant benefits for all stakeholders involved in the milk collection process, including milk producers, cooperative societies, milk unions, and state federations. Key features and benefits of the app include:
  - Increased transparency among stakeholders
  - Online monitoring of daily milk poured at Milk Cooperative Societies
  - Real-time milk price updates from the cloud server, ensuring transparency and eliminating human errors
  - Direct beneficiary transfers of milk payment and government subsidies to the milk producers’ bank accounts through the app
  - Push notifications for milk collection to the milk producers’ app
  - Multilingual app with support for English, Hindi, Punjabi, Telugu, and more



## Nyaya Vikas Portal

### Why in News

Nyaya Vikas Portal, Monitoring the Implementation of Centrally Sponsored Scheme Nyaya Vikas.

### Important Points

- Recently, Nyaya Vikas Portal was created by the Department of Justice for monitoring the implementation of Centrally Sponsored Schemes.
- The Nyaya Vikas Portal offers stakeholders four convenient methods to log in, providing them with effortless access to funding details, documentation, project monitoring, and approval information.



- Nyaya Vikas Scheme is a Centrally Sponsored Scheme (CSS) implemented by the Department of Justice to improve the infrastructure facilities and housing for the district and subordinate judiciary in India.

### About Nyaya Vikas Scheme

- Since 1993-94, the Department of Justice has been actively involved in the implementation of the Centrally Sponsored Scheme (CSS) Nyaya Vikas for the Development of Infrastructure Facilities for Districts and Subordinate Judiciary.
- The Nyaya Vikas scheme aims to enhance and improve the infrastructure facilities available to the judiciary at the district and subordinate levels.
- Objective: The Scheme Aims to improve physical infrastructure of the sub-ordinate courts as also the housing needs for the judicial officers of District and Subordinate Courts in the country with a view to facilitate better Justice Delivery.
- Coverage and Scope: The scheme covers all the States and Union Territories. The Scheme covers construction of judicial buildings and construction of residential accommodation or Judges and Judicial officers of District and Subordinate Courts in the States.

### The scheme includes three new elements:

- Construction of Lawyer Halls
- Toilet Complexes
- Digital computer rooms convenience of lawyers and litigants.

### Funding

- The fund sharing pattern between the Center and the State, with a ratio of 60:40 for States other than North Eastern and Himalayan States.
- For North Eastern and Himalayan States, the ratio is 90:10, and for Union Territories, it is 100%.
- To ensure effective implementation of the Nyaya Vikas Scheme, a dedicated portal has been established for monitoring its progress.

### Features

- The Nyaya Vikas Scheme provides central assistance to State Governments and Union Territory Administrations for the construction of court halls and residential units for Judicial Officers and Judges of District and Subordinate Courts.
- With the recent extension of the scheme additional features such as Lawyers Halls, Toilet complexes, and Digital computer rooms have been incorporated to enhance convenience for lawyers and litigants, in addition to court halls and residential units.

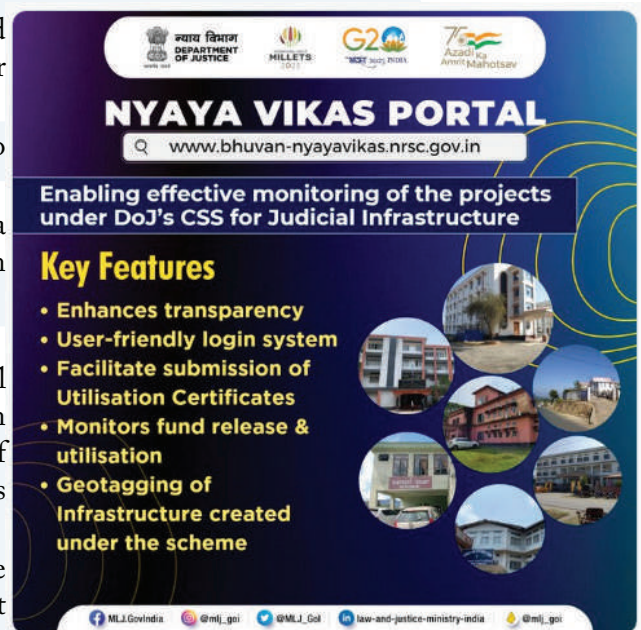

## Pradhan Mantri Bhartiya Janaushadhi Pariyojana (PMBJP)

### Why in News

Centre allows Primary Agricultural Credit Societies to open Jan Aushadhi Kendras

### Important Points

- The Central Government has decided to allow 2,000 Primary Agricultural Credit Societies (PACS) to open Pradhan Mantri Bhartiya Jan Aushadhi Kendras across the country.
- The decision was taken in a meeting of Union Home Minister and Minister of Cooperation in New Delhi.
- 2,000 PACS across the country will be identified to open Pradhan Mantri Bhartiya Jan Aushadhi Kendras.
- 1,000 Pradhan Mantri Bhartiya Jan Aushadhi Kendras will be opened by August and 1,000 by December, this year.

- This decision will not only increase the income of PACS and create employment opportunities but will also make medicines available at affordable prices to the people, especially those living in rural areas.
- More than 9,400 Pradhan Mantri Bhartiya Jan Aushadhi Kendras have been opened across the country till now.
- 1800 types of medicines and 285 other medical devices are available in these Jan Aushadhi Kendras.
- Medicines at Pradhan Mantri Bhartiya Jan Aushadhi Kendras are available at 50% to 90% lesser rate in comparison to the branded medicines.

#### Eligibility Criteria:

- The Eligibility Criteria for the Individual applicants to open Pradhan Mantri Bhartiya Jan Aushadhi Kendra is to have D. Pharma/B. Pharma. Any organization, NGO, charitable organization and hospital can apply for this by appointing B.Pharma / D.Pharma degree holders.

#### Application Fee

- For opening Pradhan Mantri Bhartiya Jan Aushadhi Kendra at least 120 square feet space either privately owned or rental should be available.
- The application fee for Jan Aushadhi Kendra is Rs.5,000.

#### Special Category

- Women Entrepreneurs, Divyang, Scheduled Castes, Scheduled Tribes and Ex-Servicemen come under Special Category. Aspirational Districts, Himalayan Mountain Region, North-Eastern States and Islands are in Special Areas.
- There is an exemption in application fee for applicants from special categories and special areas.

#### Incentive

- The incentive amount for Pradhan Mantri Bhartiya Jan Aushadhi Kendra is Rs.5 lakh (15% of monthly purchase or maximum of Rs.15,000 per month).
- One time additional incentive of Rs. 2 lakh as reimbursement for IT and infra expenditure in special categories and areas is also provided.

## VAIBHAV fellowships Programme

### Why in News

The Government of India has launched a new fellowship programme to connect the Indian Science, Technology, Engineering, Mathematics and Medicine (STEMM) diaspora with Indian academic and R&D institutions.

### Important Points

- The program aims to connect the Indian STEMM (Science, Technology, Engineering, Mathematics, and Medicine) diaspora with Indian academic and R&D institutions.
- It promotes collaborative research work, knowledge sharing, and the exchange of best practices in frontier areas of science and technology.

### Implementation and Eligibility

- Implementing Agency : Department of Science and Technology (DST), Ministry of Science and Technology.
- Beneficiaries: outstanding scientists/technologists of Indian origin (NRI/OCI/PIO) engaged in research activities in their respective countries.
- Benefits: Grant of INR 4,00,000 per month, international and domestic travel expenses, accommodation, and contingencies
- Verticals identified: 75 fellows will be selected to work in 18 identified knowledge verticals, including quantum technology, health, pharma, electronics, agriculture, energy, computer sciences, and material sciences.



- Collaborations: The VAIBHAV Fellow will collaborate with Indian Higher Educational Institutions (HEIs), universities, and/or public-funded scientific institutions.
- R&D Activity: The fellow can spend up to 2 months per year, for a maximum of 3 years, in an Indian institution.

#### **VAIBHAV Summit**

- The Government of India organized the VAIBHAV Summit to connect the Indian STEM diaspora with Indian institutions.
- The summit was inaugurated by the Hon'ble Prime Minister and saw the participation of over 25,000 attendees.
- Indian STEM diaspora from more than 70 countries took part in the deliberations.

## **SANKALP Programme**

### **Why in News**

Recently, the Ministry of Skill Development & Entrepreneurship (MSDE) certifies 98 trainers trained under the SANKALP programme.

### **Important Points**

- This initiative was carried out in collaboration with the Automotive Sector Development Council (ASDC), GIZ-IGVET, and the Maharashtra State Skill Development Mission (MSSDS).
- The project, developed as part of the National component of Skill Acquisition and Knowledge Awareness for Livelihood Promotion (SANKALP), aimed to enhance the skills of trainers in various trades such as Advanced Welding, CNC operations, Robotics, Quality Control, and Advanced Automotive Technology.

### **Implementing Ministry:**

- The Ministry of Skill Development & Entrepreneurship (MSDE) spearheaded the cluster-based Training of Trainers project in collaboration with key stakeholders, including the Automotive Sector Development Council (ASDC), GIZ-IGVET, and the Maharashtra State Skill Development Mission (MSSDS).
- The project sought to bridge the skills gap by involving industry members in curriculum development and upgrade the technical and pedagogical skills of trainers in line with industry 4.0 requirements.

### **Key Features:**

- Dual Certification: The trainers who participated in the ToT program received dual certification after undergoing assessments conducted by the Automotive Sector Development Council and IGCC (German certification agency). This certification ensures their competence in delivering high-quality training in their respective trades.
- Public-Private Partnership: The initiative fostered a strong public-private partnership in the Technical and Vocational Education and Training (TVET) domain. Collaborations with organizations such as Sukhakarta General Engineering Cluster Pvt. Ltd. (SGECPL) in Pune facilitated the successful implementation of the ToT program.
- Classroom and On-the-Job Training: The ToT program comprised one-month classroom training followed by one-month on-the-job training. This comprehensive approach equipped trainers with both theoretical knowledge and practical skills necessary for effective training delivery.

### **Benefits:**

- Skill Enhancement: The ToT program aimed to enhance the skills of trainers in the automotive sector, preparing them to meet the evolving demands of the industry. By upgrading their technical and pedagogical skills, the program contributed to the development of a highly competent workforce.
- Industry Alignment: Involving industry members in curriculum development ensured that the training programs were aligned with industry 4.0 requirements. This collaboration bridged the skills gap and facilitated a smooth transition for trainees into the automotive sector.

### **Vision:**

- The certification ceremony for the cluster-based Training of Trainers project highlighted the commitment of the Ministry of Skill Development & Entrepreneurship to create a pool of highly skilled trainers.
- By prioritizing Training of Trainers (ToT) programs, the government aims to build a competent and robust workforce across various sectors, thereby multiplying the impact of skill development initiatives.



## PM Matru Vandana Yojana

### Why in News

Recently, The Prime Minister of India has lauded the new initiative of celebrating 'Pradhan Mantri Matru Vandana Yojana' as 'God Bharai' ceremony in Dausa, Rajasthan.

### Important Points

- It is a Centrally Sponsored Direct Benefit Transfer (DBT) scheme launched in 2017.

### Objectives

- Providing partial compensation for the wage loss in terms of cash incentive, so that the woman can take adequate rest before and after delivery of the first child
- To improve health-seeking behaviour amongst Pregnant Women & Lactating Mothers (PW&LM).

### Features

- The scheme is to provide maternity benefits to women belonging to socially and economically disadvantaged sections of society.
- The maternity benefit is to be provided to a woman for the first two living children provided the second child is a girl
- Under this scheme monetary benefit of Rs. 5,000 is given to the expecting mothers from the time of the initial stage of pregnancy to till the time the child is born.
- Additionally, Rs. 1,000 is provided under the Janani Suraksha Yojana post-institutional delivery.
- The Rs. 5,000 is provided in three installments.
- The first installment of Rs. 1,000 is paid at the time of registration of the pregnancy.
- The second installment of Rs. 2,000 is paid at the time of completing 6 months of pregnancy and receiving at least one antenatal checkup.
- The third installment of Rs. 2,000 is received after the birth and registration of birth of such child and after such child receives the first cycle of immunization for BCG, OPV, DPT and Hepatitis-B.
- Cases of miscarriage/stillbirths are to be treated as fresh cases for providing maternity benefits under the scheme.

## Poshan Tracker App

### Why in News

More than 57,000 migrant workers have registered for the special one nation one Anganwadi programme by using the Poshan Tracker App on mobile phones.

### Important Points

- This application provides a 360-degree view of the activities of the Anganwadi Centre (child care centers), service deliveries of Anganwadi Workers and complete beneficiary management for pregnant women, lactating mothers and children under six.
- It also digitizes and automates physical registers used by workers to help improve the quality of their work.
- The Anganwadi workers are being provided smartphones procured through Government e-Market (GeM) for efficient service delivery.
- A nodal person has also been appointed for providing technical support and resolving any issue with downloading the new Poshan Tracker application and its functioning in each state.
- The sources that each migrant worker who had registered in their original state could go to the nearest Anganwadi in their current place of residence and avail of the schemes and services offered.
- It was launched by the Ministry of Women and Child Development (MoWCD).

### What is Poshan Abhiyaan?

- It was launched by the Prime Minister of India on 8th March 2018 and has been instrumental in ensuring people's participation and bringing the discourse on nutrition to the forefront.
- It was launched to improve nutritional outcomes holistically.
- The focus of Abhiyaan is to emphasize the nutritional status of adolescent girls, pregnant women, lactating mothers and children from 0-6 years of age.
- The programme, through the use of technology, convergence and community involvement with a targeted approach strives:
- To reduce the level of stunting, undernutrition, Anaemia and low birth weight in children.

## Chapter- 9

# MISCELLANEOUS

## ERSO

### Why in News

MeitY launches pilot project on Electronics Repair Services Outsourcing (ERSO)

### Important Points

- Ministry of Electronics and Information Technology (MeitY) launched the Electronics Repair Services Outsourcing (ERSO) initiative to help India become a leader in electronics repair.
- The pilot project is being conducted in Bengaluru and will run for three months starting from March 31.
- The project has been identified as a game-changer for India and the ERSO industry is likely to fetch India up to \$20 billion in revenue and also generate millions of jobs over the next five years.
- The policy and process changes required for the ERSO initiative have been introduced over the last few months by different departments of the government after in-depth consultations with the Repair Industry.
- According to the ministry, MeitY, Central Board of Indirect Taxes and Customs (CBIC), Director General of Foreign Trade (DGFT), and Ministry of Environment, Forest and Climate Change worked together with the repair industry on the policy which seeks to make India an attractive destination for the repair of electronics.
- Five companies -- Flex, Lenovo, CTDI, R-Logic, and Aforeserve -- have volunteered for the pilot project. After the pilot is completed, a detailed assessment will be carried out by the IT ministry and modifications will be made to the process and policy, the release said.
- The ERSO project will support Mission LiFE. Mission LiFE was launched by Prime Minister Narendra Modi at the 2021
- UN Climate Change Conference (UNFCCC COP26) to bring individual behaviors to the forefront of the global climate action narrative.
- It aims the replacing the 'use-and-dispose' economy with a circular economy model, which would be defined by "mindful and deliberate utilisation". The mission seeks to nudge individuals to undertake simple acts in their daily lives that can mitigate climate change
- The policy and process changes required for ERSO have been introduced over the last few months by different departments of the Government after in-depth discussions with the Repair Industry and are being validated for their efficacy and efficiency through a limited pilot that has been launched.
- In line with the clarion call of Prime Minister to support Mission LiFE, the ERSO initiative will be a gamechanger for Global environmental sustainability and reiterates India's commitment to the environment and our planet.
- It will enable extension of device life globally by providing cheap and reliable repair of ICT products for the globe.



## National Electricity Plan

### Why in News

Central Electricity Authority notifies the National Electricity Plan for the period of 2022-32

### Important Points

- The Central Electricity Authority (CEA) has notified the National Electricity Plan (NEP) for the period of 2022-32.

- The plan document, which was released today via e-Gazette, includes the review of the last five years (2017-22), a detailed plan for the next five years (2022-27) and the prospective plan for the next five years (2027-32).
- According to the NEP document, the projected All India peak electricity demand and electrical energy requirement is 277.2 GW and 1907.8 BU for the year 2026-27 and 366.4 GW and 2473.8 BU for the year 2031-32 as per 20th Electric Power Survey (EPS) Demand projections.
- The Energy Requirement & Peak Demand are inclusive of the impact due to increased adoption of Electric Vehicles, Installation of Solar roof tops, Production of Green hydrogen, Saubhagya scheme etc.
- Based on generation planning studies carried out under the purview of preparation of National Electricity Plan for the period of 2022-27, the likely Installed Capacity for the year 2026-27 is 609,591 MW comprising of 273,038 MW of Conventional capacity (Coal-235,133MW, Gas-24,824MW, Nuclear-13,080MW) and 336,553 MW of Renewable based Capacity (Large Hydro-52,446 MW, Solar-185,566 MW Wind-72,895 MW, Small Hydro-5,200 MW, Biomass-13,000MW, Pump Storage Plants (PSP projects) -7446MW) along with BESS capacity (Battery Energy Storage System) of 8,680MW/34,720 MWh.
- The likely Installed Capacity for the year 2031-32 is estimated to be 900,422 MW comprising of 304,147 MW of Conventional capacity (Coal-259,643 MW, Gas-24,824MW, Nuclear-19,680MW) and 596,275MW of Renewable based Capacity (Large Hydro-62,178 MW, Solar-364,566MW, Wind-121,895MW, Small Hydro-5450MW, Biomass-15,500 MW, PSP-26,686MW; excluding 5856 MW of likely Hydro based Imports) along with BESS capacity of 47,244MW/236,220MWh.
- The projection of total capacity addition is in line with the target of the country to achieve a non-fossil based installed capacity of around 500 GW by the year 2029-30.
- NEP envisages that the share of non-fossil based capacity is likely to increase to 57.4% by the end of 2026-27 and may likely to further increase to 68.4% by the end of 2031-32 from around 42.5% as on April'2023.
- The average PLF of the total Installed coal capacity of 235.1 GW is likely to be about 58.4% in 2026-27 and that of 259.6 GW of coal based capacity is likely to be about 58.7 % in 2031-32.
- As per the National Electricity Plan projections, the energy storage capacity of 16.13 GW/82.37 GWh with PSP based storage of 7.45GW capacity and 47.65 GWh storage and BESS based storage of 8.68 GW/ 34.72 GWh is required by the year 2026-27. The storage capacity requirement increases to 73.93 GW (26.69 GW PSP and 47.24 GW BESS) with storage of 411.4 GWh (175.18 GWh from PSP and 236.22 GWh from BESS) by the year 2031-32.
- The domestic coal requirement has been estimated to be 866.4 Million Tonnes for the year 2026-27 and 1025.8 Million Tonnes for the year 2031-32 and estimated requirement of 28.9 MT of coal imports for the plants designed to run on imported coal.
- The total fund requirement for generation capacity addition for the period 2022-2027 is estimated to be Rs. 14,54,188 Crores and for the period 2027-2032 has been estimated to be Rs. 19,06,406 Crores. The estimate of fund requirement for 2027-32 does not include advance action for the projects which may get commissioned after 31.03.2032.
- The average emission factor is expected to reduce to 0.548 kg CO<sub>2</sub>/kWh<sub>net</sub> in the year 2026-27 and to 0.430 kg CO<sub>2</sub>/kWh<sub>net</sub> by the end of 2031-32.
- As per section 3(4) of the Electricity Act, 2003, Central Electricity Authority has been mandated to prepare a National Electricity Plan (NEP) in accordance with the National Electricity Policy and notify such plan once in five years.

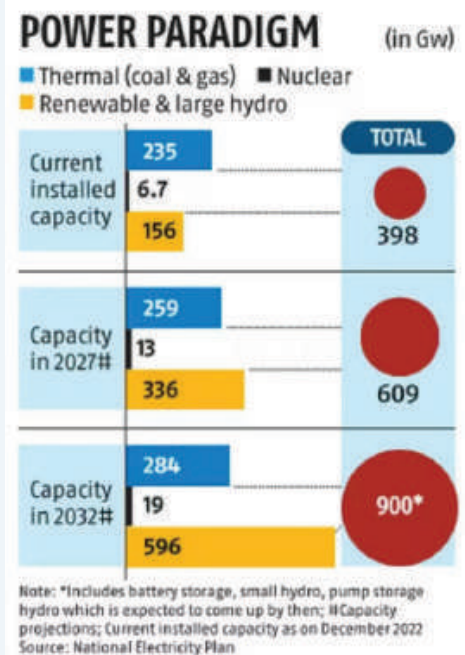

### Central Electricity Authority (CEA)

- It is a statutory body, which has been constituted under the Electricity Act, 2003.



## Functions

- It advises central government on the matters relating to the national electricity policy, formulate short-term and perspective plans for development of the electricity system.
- It also specifies technical standards and safety requirements for electrical plants, and electric lines.
- Regulate inter-State transmission of electricity, regulate tariff of generating companies etc.

## TAPAS UAV

### Why in News

In a remarkable feat, the Indian Navy and the Defence Research and Development Organisation (DRDO) has successfully carried out the transfer of command and control capabilities of TAPAS Unmanned Aerial Vehicle (UAV).

### Important Points

- In a remarkable feat, the Indian Navy and the Defence Research and Development Organisation (DRDO) has successfully carried out the transfer of command and control capabilities of TAPAS Unmanned Aerial Vehicle (UAV).
- 
- The demonstration involved commanding the UAV from a distant ground station to the onboard INS Subhadra, a warship situated 148 km away from Karnataka's Karwar naval base.
  - Tapas UAV operated at an altitude of 20,000 feet above sea level and completed three-hour and 30-minute flight, with the INS Subhadra assuming control of the operations for 40 minutes.
  - The Tapas UAV took off from the Aeronautical Test Range (ATR) in Chitradurga and covered 285km distance to reach the naval base.
  - To facilitate the control of the UAV, one Ground Control Station and two Ship Data Terminals were installed on the INS Subhadra, DRDO said in a statement.
  - Following the successful trial, the Tapas UAV landed back at the ATR.
  - The Tapas UAV, developed by DRDO, is a Medium Altitude Long Endurance (MALE) unmanned aerial vehicle.
  - The vehicle, which was publicly showcased during its first flight at Aero India 2023 in Bengaluru earlier this year, has a range of more than 18 hours and can operate at altitudes of up to 28,000 feet.
  - It was developed in response to the ISTAR (Intelligence, Surveillance, Target Acquisition, Tracking, and Reconnaissance) requirements of the tri-services.

### About ISTAR

- ISTAR (intelligence, surveillance, target acquisition, and reconnaissance) aircraft can provide India with a powerful tool for increasing battlefield transparency and situational awareness.
- It can be used to track and monitor enemy troops and assets, as well as gather intelligence on enemy movements and intentions. This data can be used to improve operations planning and execution.
- These planes can also be used to precisely target enemy forces and infrastructure and carry out precision strikes.
- This can help reduce the risk of collateral damage and civilian casualties while increasing the likelihood of boots-on-the-ground success.
- ISTAR is a multi-intelligence aircraft that uses artificial intelligence, integrated onboard sensors, and advanced processing to provide vital information to military and civilian air and ground crews.
- The ISTAR aircraft can track mobile land targets as well as monitor ships and activity along borders and coastal zones.
- It can also be used in conjunction with a fixed or mobile command and control station.
- Another critical application of the ISTAR systems could be mapping natural disaster areas.

## Child Trafficking in India

### Why in News

Recently World Day Against Child Labour is observed annually on June 12.

### Important Points

- It aims to serve as a catalyst for the growing worldwide movement against child labour.
- The UN believes child labour can be eliminated from the world if people and governments focus on the root cause and understand social justice and child labour are interlinked.
- The day calls for “reinvigorated international action to achieve social justice, particularly under the envisaged Global Coalition for Social Justice and universal ratification of ILO Convention No 138 on Minimum Age, which, together with the universal ratification of ILO Convention No 182 on Worst Forms of Child Labour achieved in 2020, would provide all children with legal protection against all forms of child labour”, according to United Nations Organisation.



### World Day Against Child Labour 2023 Theme:

- The theme for World Day Against Child Labour is ‘Social Justice for All. End Child Labour!’. It emphasized the link between social justice and child labour.

### World Day Against Child Labour 2023 History and Significance:

- This year, we will mark the 21st World Day Against Child Labour. The origin of this day can be traced back to 2000.
- For nearly two decades, there has been steady progress in reducing child labour.
- However, conflicts, crises and the COVID-19 pandemic have plunged more families into poverty and forced millions more children into child labour.
- World Day Against Child Labour is a reminder that child labour practices are a severe problem, and it is necessary to address this issue.
- Child labour robs children of their innocence, their rights, and normal childhood as they are forced to work in harsh conditions and often subjected to trauma.
- It is important to support and observe this day to amplify the message of eradicating this inhuman practice.

### According to UN

- According to the official website of the United Nations, approximately 160 million children worldwide are involved in child labour, which represents 1 in 10 children.
- From 2000 to 2020, child labour decreased by 85.5 million, dropping from 16 per cent to 9.6 per cent.
- Only 26.4 per cent of children worldwide receive social protection cash benefits.
- Globally, only 1.1 per cent of GDP is spent on social protection for children and only 0.4 per cent of GDP for children in Africa.
- Without mitigation strategies, child labour could increase by 8.9 million by the end of 2022

### Laws governing Anti-Trafficking Crimes:

- Immoral Traffic (Prevention) Act 1956 stop immoral trafficking and sex work.
- Bonded Labour System (Abolition) Act 1976 abolishes bonded labour system to prevent economic and physical exploitation of weaker sections of people.
- Transplantation of Human Organs and Tissues Act 1994 makes commercial dealing in human organs a punishable offence.
- Protection of Children from Sexual Offences (POCSO) Act 2012 prevents commercial sexual exploitation of children.

## India Rankings 2023

### Why in News

Ministry of Education has released 8th edition of India Rankings of Higher Educational Institutions in Country.

### Important Points

- Indian Institute of Technology-Madras ranked first in overall higher education institutions in the eighth edition of the National Institute Ranking Framework, (NIRF) rankings 2023, as per the NIRF Ranking released by the Union Ministry of Education.
- Indian Institute of Technology, Madras tops the Ministry of Education's India Rankings 2023 of Higher Educational Institutions; Indian Institute of Science (IISc), Bengaluru and IIT-Delhi claimed the second and third spots respectively.

Overall	
Name	2023 Rank
Indian Institute of Technology Madras	1
Indian Institute of Science Bengaluru	2
Indian Institute of Technology Delhi	3
Indian Institute of Technology Bombay	4
Indian Institute of Technology Kanpur	5
All India Institute of Medical Sciences, Delhi	6
Indian Institute of Technology Kharagpur	7
Indian Institute of Technology Roorkee	8
Indian Institute of Technology Guwahati	9
Jawaharlal Nehru University	10

### 2023 edition of India Rankings

- Introduced a new subject namely Agriculture & Allied Sectors
- Integrated "Innovation" ranking previously executed by Atal Ranking of Institutions on Innovation Achievements (ARIIA) into India Rankings.
- Expansion of scope of "Architecture" to "Architecture and Planning".
- In the Universities category, the Indian Institute of Science, Bengaluru was named the top university in the India Rankings 2023 of Higher Educational Institutions; Jawaharlal Nehru University and Jamia Millia Islamia from Delhi secured second and third ranks respectively.
- In the top 10 colleges of the country as per India Ranking 2023, Miranda House, New Delhi was named the top college and Hindu College, New Delhi ranked third and Presidency College, Chennai ranked third.
- In the Engineering category India Ranking 2023, the Indian Institute of Technology-Madras was named the top institution while the Indian Institute of Technology-Delhi and Bombay ranked second and third position in the country.
- In Management Categories, IIM Ahmedabad ranked first while IIM Bangalore and Kozhikode ranked second and third position, as per NIRF ranking 2023.
- In the Medical category, the top three institutions are the All India Institute of Medical Sciences, Delhi, Post Graduate Institute of Medical Education and Research, Chandigarh and Christian Medical College, Vellore.
- The top three Law institutions in the country are the National Law School of India University, Bengaluru, National Law University, New Delhi and Nalsar University of Law, Hyderabad.

### About National Institute Ranking Framework, (NIRF)

- The Ministry of Education established the National Institutional Ranking Framework (NIRF) in 2016 to determine the critical indicators on which institutions' performance could be measured.
- The National Institutional Ranking Framework is a methodology adopted by the Ministry of Education, to rank institutions of higher education in India.

### Parameters:

- Teaching, Learning and Resources (TLR) (30% weightage),
- Research and Professional Practice (RP) (30% weightage),
- Graduation Outcomes (GO) (20% weightage),
- Outreach and Inclusivity (OI) (10% weightage) and
- Perception (PR) (10% weightage).

## Research & Analysis Wing (RAW)

### Why in News

Recently IPS officer Ravi Sinha appointed as a new RAW chief

### Important Points

- Senior IPS officer Ravi Sinha is appointed as the chief of the country's external spy agency RAW, succeeding Samant Kumar Goel who will complete his four-year tenure.



- Sinha, a 1988 batch Indian Police Service (IPS) officer of the Chhattisgarh cadre, is currently Special Secretary in the Cabinet Secretariat.
- The Appointments Committee of the Cabinet has approved Sinha's appointment as Secretary, Research and Analysis Wing (RAW) for a tenure of two years, the order issued by the Ministry of Personnel.
- Sinha has been with the prestigious intelligence agency for over two decades.
- He was heading the operational wing of RAW before his promotion. Considered a neighbourhood specialist, the officer has worked extensively in Jammu and Kashmir, northeast and other countries.
- He takes over at a time when Sikh extremism is being propagated from some countries.
- Sinha's predecessor Goel was appointed RAW chief for two years in June 2019. He was later given two extensions of one year each in 2021 and June 2022.
- Goel, an expert on matters related to Jammu and Kashmir, is believed to have played a key role in planning in the surgical strike in Pakistan's Balakot.
- The surgical strike was carried out to avenge the Pulwama terror attack, in which 40 Central Reserve Police Force (CRPF) personnel were killed by a suicide bomber of Pakistan-based Jaish-e-Mohammed (JeM).
- In response to the attack, the Indian Air Force had struck a JeM terrorist training camp in Balakot.



#### About RAW

- Research and Analysis Wing (RAW) is India's premier intelligence agency and was created in 1968 to handle India's external intelligence affairs.
- The chief of RAW is designated secretary (research) in the Cabinet Secretariat, which is part of the prime minister's office.
- RAW reports directly to the prime minister instead of the Ministry of Defense.
- Since its inception, RAW is credited with providing intelligence support to many significant operations on foreign soil.

#### History:

- Until 1968, the Intelligence Bureau (IB) was handling both the internal and external intelligence.
- After the 1962 border war with China, the need for a separate external intelligence agency was felt. During that conflict, our intelligence failed to detect Chinese build up for the attack.
- As a result, India established a dedicated external intelligence agency, the Research and Analysis Wing.
- Founded mainly to focus on China and Pakistan, over the last forty years the organization has expanded its mandate and is credited with greatly increasing India's influence abroad.
- In 1968, Prime Minister Indira Gandhi appointed R. N. Kao as the first director of RAW.

#### Structure of RAW

- R&AW has been organised on the lines of the CIA. The head of R&AW is designated Secretary (R) in the Cabinet Secretariat.
- The Secretary (R), is under the direct command of the Prime Minister, and reports on an administrative basis to the Cabinet Secretary, who reports to the Prime Minister.

#### RAW's objectives:

- Monitoring the political, military, economic and scientific developments in countries which have a direct bearing on India's national security and the formulation of its foreign policy.
- Mold international public opinion and influence foreign governments.
- Covert Operations to safeguard India's National interests.
- Anti-terror operations and neutralising elements posing a threat to India.
- Seeking the control and limitation of the supply of military hardware to Pakistan, mostly from European countries, the United States, and China.

## Operation Amanat

### Why in News

The Railway Protection Force (RPF) recently conducted a successful operation named “Amanat,” resulting in the retrieval of lost or left-behind luggage and valuable articles.

### Important Points

- Under the Operation Amanat initiative, the Railway Protection Force has taken a novel initiative to make it easier for the passengers to get back their lost luggage.
- It helps to track lost belongings of passengers.
- The details of lost luggage along with photos are uploaded by RPF personnel of the respective Divisions.
- Passengers can check whether their luggage which went missing or was lost in railway premises or trains is available at the Lost Property Office centres at stations.



### Key facts about Railway Protection Force (RPF):

- It is a security force of India entrusted with protecting railway passengers, passenger area and railway property of the Indian Railways.
- It was established by the Railway Protection Force Act, 1957.
- It has the power to search, arrest, Enquiry, and prosecute offenses committed under Railway Property (Unlawful Possession) Act 1966, The Railways Act, 1989 (amended from time to time).
- This is only central armed police force (CAPF, commonly known as Para-Military force) which has power to arrest, investigate and prosecute criminals.
- The force is under the authority of the Indian Ministry of Railways.
- All the officers of RPF are members of the Indian Railway Protection Force Service (IRPFS) and are recruited through UPSC Civil Services Examination.
- It is headed by the Director General (DG). However, the post of Director-General of RPF is held on deputation by a senior Indian Police Service (IPS) officer.

## Mineral Security Partnership

### Why in News

India was recently inducted into the Mineral Security Partnership (MSP).

### Important Points

#### About Mineral Security Partnership:

- It is an ambitious new initiative to bolster critical mineral supply chains, announced by the United States (US) and key partner countries in June 2022.
- The goal of the alliance is to ensure that critical minerals are produced, processed, and recycled in a manner that supports the ability of countries to realise the full economic development benefit of their geological endowments.
- The focus of the grouping would be on the supply chains of minerals such as Cobalt, Nickel, Lithium and also the 17 “rare earth” minerals.

#### What is a critical mineral?

- There is no global definition of critical minerals, but essentially, they are mineral deposits with high economic vulnerability and high global supply chain risk.

#### What are major critical minerals?

- The major critical minerals are Graphite, Lithium and Cobalt.
- They are used for making EV batteries and are also critical for making semiconductors and high-end electronics manufacturing.
- These minerals are also used in manufacturing fighter jets, drones, radio sets and other critical equipment.

#### Who are the top producers of critical minerals?

- The major producers of critical minerals globally are Chile, Indonesia, Congo, China, Australia and South Africa.

#### What are rare earth elements?

- The 17 rare earth elements (REE) include the 15 Lanthanides (atomic numbers 57 — which is Lanthanum — to 71 in the periodic table) plus Scandium (atomic number 21) and Yttrium (39).

## Global Liveability Index 2023

### Why in News

Recently, the Economist Intelligence Unit (EIU) unveiled its highly anticipated Global Liveability Index 2023.

### Important Points

- The Economist Intelligence Unit (EIU) has recently unveiled its highly anticipated list of the ‘Most Liveable Cities in the World 2023’.



### About Global Liveability Index 2023:

- Through an evaluation of five metrics, including healthcare, culture, environment, education, and stability, this ranking offers insights into the cities that excel in providing an exceptional quality of life.
- This year, the index covered 172 cities and for the second year in a row, Vienna, Austria, has been named the best city to live in the world.
- The Global Liveability Index 2023 attributed Vienna's success to its “unsurpassed combination of stability, good infrastructure, strong education and healthcare services, and plenty of culture and entertainment.”
- Denmark's capital Copenhagen also retained its second-place position in the list.
- Following it are two Australian cities, Melbourne and Sydney, respectively.
- Three Canadian cities – Vancouver, Calgary and Toronto — also made it to the top ten list.
- From Asia, Japan's Osaka was ranked number 10 in the rankings.
- According to EIU, the index rose last year to reach a 15-year high as the world recovered from the pandemic.
- The average index score is now 76.2 out of 100, up from 73.2 a year ago.
- Despite overall growth in the index score, stability saw a marginal decline.

### Least livable cities are:

- The cities which are plagued by ongoing civil unrest and military conflicts, amongst other issues, remained at the bottom of the list.
- Algeria's Algiers, Libya's Tripoli and Syria's Damascus were ranked the three least liveable cities in the world.
- Damascus has consistently been ranked as one of the lowest-ranked cities in the survey.
- It has seen no improvement in its liveability scores this year.

## Nano Urea

### Why in News

Indian Farmers Fertiliser Cooperative Ltd (IFFCO) recently said it had signed an agreement with California-based Kapoor Enterprises Inc to export liquid nano urea to the US.

### Important Points

#### About Nano Urea:

- It is a nanotechnology-based revolutionary Agri-input that provides nitrogen to plants.
- It is developed and patented by the Indian Farmers Fertiliser Cooperative Limited (IFFCO).
- IFFCO Nano Urea is the only nano fertiliser approved by the Government of India and included in the Fertilizer Control Order (FCO).

#### Features:

- Compared to conventional urea prill, Nano Urea has a desirable particle size of about 20-50 nm and more surface area (10,000 times over 1 mm urea prill) and the number of particles (55,000 nitrogen particles over 1 mm urea prill).
- It contains 4.0 % total nitrogen.





**Benefits:**

- It is produced by an energy-efficient, environment-friendly production process with less carbon footprints.
- Increased availability to crop by more than 80%, resulting in higher nutrient use efficiency.
- It is expected to improve crop productivity, soil health, and nutritional quality of produce and address the “imbalanced and excessive use” of conventional fertiliser.

**Indian Farmers Fertiliser Cooperative Limited (IFFCO):**

- It is India’s largest multi-state cooperative society that is entirely owned by Indian cooperatives.
- IFFCO is primarily engaged in the production and distribution of fertilisers.
- Headquarters: New Delhi, India.

**National Florence Nightingale Awards****Why in News**

President of India presents National Florence Nightingale Awards for 2022 and 2023

**Important Points**

- President of India bestowed the National Florence Nightingale Awards for the years 2022 and 2023 to nursing professionals during a ceremony held at Rashtrapati Bhavan.
- These prestigious awards were established by the Ministry of Health and Family Welfare, Government of India, in 1973 to honor the exceptional contributions made by nurses and nursing professionals to society.
- The Devrani sisters, hailing from Kotdwar district of Uttarakhand, were awarded in recognition of their remarkable contribution and service for almost four decades.

**National Florence Nightingale Awards**

- The National Florence Nightingale Awards were instituted in the year 1973 by the Indian government.
- Aim: The primary objective of these awards is to acknowledge and appreciate the remarkable work of nurses across India. The awards encourage and motivate nurses to continue their dedicated service and strive for excellence in patient care.
- Recognition: The National Florence Nightingale Awards are considered one of the highest honors in the nursing profession in India. They highlight the significant role nurses play in the healthcare system and recognize their selfless commitment to saving lives and promoting well-being.
- Selection Process: The selection of awardees is a rigorous and competitive process. The Ministry of Health and Family Welfare, Government of India, invites nominations from various healthcare institutions, including hospitals, nursing schools, and medical colleges. The nominations are evaluated by a committee comprising eminent healthcare professionals.
- Award Ceremony: The ceremony is typically held in New Delhi and is attended by dignitaries, government officials, nursing professionals, and other stakeholders in the healthcare sector.
- Award Categories: The National Florence Nightingale Awards are presented in different categories to recognize various aspects of nursing excellence. These categories may include Auxiliary Nurse and Midwife, Lady health visitors and Nurse.
- The award carries a cash prize of Rs 50000/-, a certificate and a medal.



**Chapter 1: AYUSH**

- The “Science of Life” is a term that is frequently used to describe the Ayush system, especially Ayurveda. It has a strong foundation in the traditional Indian knowledge structure.
- The Ministry of Ayush (MoA) is continuously working to spread awareness of the Ayush healthcare systems.
- As a result, funding for research institutions has grown, and Ayush specialists and contemporary scientists are now working together.
- The Ministry of Ayush seeks to close the knowledge gap between traditional wisdom and the most recent scientific research. This will guarantee that Ayush is incorporated into medical procedures that are supported by evidence.

**R&D initiatives of Ministry of Ayush**

- Five Research Councils have been formed by the MoA as Autonomous Institutes for the study of Ayurveda, Unani, Homoeopathy, Siddha, Yoga, and Naturopathy.
- Scientific research on medicinal plants and drug standardisation are among the scientific efforts. Clinical research, pharmaceutical research, etc.
- Ayush encourages collaboration among researchers, practitioners, and experts from various disciplines.
- By fostering interdisciplinary research and collaborative partnerships, Ayush aims to leverage diverse perspectives and expertise to find innovative solutions.
- During the Global Ayush Investment and Innovation Summit held in 2022, the Prime Minister announced the launching of Ayush mark to recognise Traditional Medicine products which will give the authenticity to quality Ayush products of the country.
- MoA works with several universities, research institutions, and international groups like CSIR, CIMR, etc.
- In order to convey legitimacy to the nation's high-quality Ayush products, the Ayush mark was also introduced to distinguish traditional medicine items.
- The Ministry is also developing guidelines for medical value travel in close collaboration with the Bureau of Indian Standards.
- There are now 17 Indian standards for herbal products, Panchkarma tools, and yoga accessories.
- The Ayush research site was created to disseminate Ayush Systems evidence-based research data on a worldwide scale.

- For academics, physicians, and stakeholders, the Ministry also arranges conferences, seminars, and training sessions.
- The potential of Ayush has been substantially supported by the National Health Policy (NHP) 2017 within a pluralistic system of Integrative healthcare.
- The WHO-Global Centre for Traditional Medicine (GCTM), the first and the only global Centre for traditional medicine is being established in Jamnagar, India.
- It strives to improve the existing medical system's scientific underpinnings.
- It will act as a leader in traditional medicine-related global health issues and support the worldwide positioning of the Ayush system.
- Assuring the effectiveness, efficacy, accessibility, and judicious use of conventional medications is one of its main tasks.
- As well as building tools and processes for data gathering, analytics, and effect assessment, it will entail creating norms, standards, and recommendations in a number of technical fields.
- The Ayush Research Portal has been set up for disseminating Evidence Based Research Data of Ayush Systems at Global Level.
- Overall, 39109 research studies in clinical, pre-clinical, drug research, and fundamental are available till date.



### Pragmatic Model

- Exploring Traditional Challenges: The research aims to explore and validate traditional knowledge and tap wisdom accumulated over centuries to find innovative approaches to health and well-being.
- Integration of Modern Scientific Methods: An Interdisciplinary Ayush Research and Development Task Force in collaboration with national organizations of repute to formulate and develop strategies for the management of Covid.
- Addressing Unmet Healthcare needs: It addresses unmet healthcare needs, especially in areas where modern medicines have limitations. For example, Brahmi Ghrita and Jyotishmati Taila in the management of Cognitive Deficit.
- Promoting Lifestyle Modification: Ayush promotes a healthy lifestyle including Yoga, meditation, dietary guidelines, and natural remedies.
- Predictive, Preventive, and Personalized Medicine: Ayush recognizes that health is influenced by multiple factors like physical, mental, spiritual, and emotional aspects. It thus fosters a comprehensive and personalized approach to healthcare.





### Ayush in achieving Universal Health Coverage

- Ayush system of healthcare forms an important part of the pluralistic foundation of healthcare in India on the principle of Swasthyasya Swasthya Rakshanam.
- Ayush healthcare system is complying with WHO's strategic objectives for achieving the 4As to Universal health Coverage- Accessibility, Affordability, Availability, and Acceptability.
- Ayush plays an important role in achieving Zero Hunger (SDG 2) through POSHAN (Prime Minister's Overarching Scheme for Holistic Nutrition) Abhiyaan under which the Ministry of Ayush is coordinating with the Ministry of WCD for management of malnutrition and anaemia in adolescent girls, pregnant women, lactating mothers, as well as children through the principle and practices of Ayurveda, Yoga, and other Ayush systems.
- Ayush diligently works towards Good health and Well-being (SDG 3).
- It also works towards Reduced inequalities (SDG 10) through National Ayush Mission (NAM) and integrated health programmes.
- Moreover, with herbal medicines Ayush supports SDG 11 'Sustainable Cities and Communities'.
- It also promotes Partnership for the Goals (SDG 17) as it promotes partnership and exchange of Knowledge and expertise.

### Conclusion

- The focal theme of initiatives like G20 presidency, WHO-GCTM, etc., is Vasudhaiva Kutumbakam meaning 'The World is One Family', a philosophy that emphasises the interdependence of all beings and the importance of cooperating to build a healthier and more equitable world.
- Ayush has always played an important part in the Indian and global healthcare system and for providing quality healthcare services to all, which is affordable and accessible.

### Chapter 2: Yoga for Global Well-being

- Yoga is a lifestyle that combines physical, mental, and spiritual well-being and goes beyond simple exercise.
- It aids in lowering the stress and anxiety that raise blood pressure, induce depression, and lead to heart disease.
- Yoga helps to improve the ability to focus by bringing clarity of thought.
- Yoga helps to improve physical health. It is an excellent mind-body practice that helps to improve flexibility, strength, endurance, and balance.
- It can also help to alleviate chronic pain, reduce inflammation, and improve respiratory functions.
- Regular yoga practice can also help to boost the immune system by improving overall health.



### Concepts and Principles of Yoga

- The principles of Ahimsa (non-violence) and Santosha (contentment) are vital in creating a harmonious society that values not just individual fulfilment but also the well-being of others.
- Ahimsa teaches us to avoid harming any living being, while Santosha reminds us to find contentment and happiness within ourselves rather than constantly seeking external validation.
- One of the fundamental principles of yoga is Aparigraha, or non-possessiveness, which teaches us to use what is necessary and to leave the rest for others.
- The Ashtanga Yoga of Maharishi Patanjali or Eight Limbs of Yoga

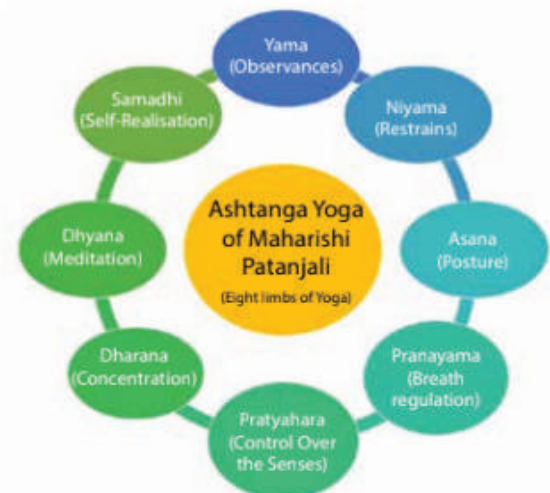

## Benefits of Yoga

- It helps in the development and maintenance of physical health and mental health.
- It helps in cultivating a deeper connection with our inner selves and with the world around us.
- It also has positive impacts on social and environmental well-being.
- It can lead to a more fulfilling and purposeful life.
- It helps in promoting mindfulness and spirituality.

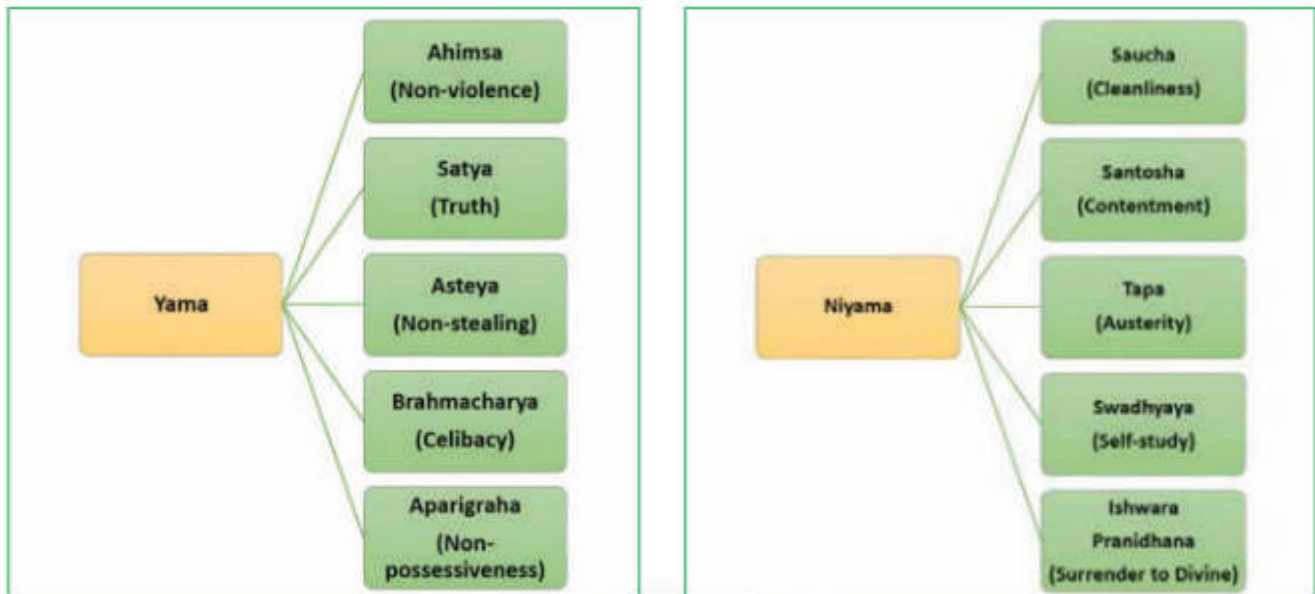

## Yogic practices for health and well-being

1. Shatkarmas – Shatkarmas, also known as purificatory practices, are essential in Hatha Yoga as they help to cleanse the body and prepare it for further practices. There are six primary shatkarmas with various subdivisions, but one can practice a few selected practices regularly.
2. Yogasana– Yogasana, or psycho-physical postures, are performed after the body is detoxified by various cleansing practices. It is believed that there are 84 lakhs different yogasanas, but the Hatha Yogic text explains 32 yogasanas that are essential.
3. Pranayama – Pranayama, or breath regulation, is one of the most important practices of yoga. Once the body is detoxified and stabilised through shatkarma and yogasana respectively, the role of pranayama comes into play.
4. Mudra & Bandha - These practices are used to control and channelise prana in the body. Mudras are body gestures, and bandhas are psychic locks that aid in maintaining the proper flow of prana in the body, leading to various health benefits.
5. Dhyana – Dhyana, or meditation, is the most important practice of yoga. Dhyana is a state of complete stillness of the mind, that helps in developing the inherent capabilities of the human mind. Various scientifically proven benefits of meditation include reduced stress, improved memory, and enhanced concentration.

## Yoga and Global Well-being

- Yoga has gained widespread popularity globally. The adoption of the International Day of Yoga on 21st June by the United Nations has popularized Yoga worldwide.
- The concept of Vasudhaiva Kutumbakam has been a part of Indian philosophies for centuries and is also closely associated with the practice of Yoga.

## Conclusion

- According to the available Yogic scriptures, the science of yoga helps to connect the individual consciousness with the universal consciousness and takes us a step closer towards attaining a disease-free body and a calm and peaceful mind. It is an art and science of life that brings an improvement in both physical and mental well-being by means of posture (asana), controlled breathing techniques (pranayama), relaxation (yoga nidra) and calms the mind through meditation (dhyana).
- Currently, the number of people adopting yoga among health-conscious people is increasing significantly.

## Chapter 3: Role of Meditational Approaches in Mental Well-Being

- The absence of sickness or disability is not sufficient to be considered healthy, according to the World Health Organisation.
- The purpose of medicine, according to Hippocrates' Science of Medicine, is to completely relieve the suffering of the ill.

### Ancient Medical Technique

- Ancient medical practises offer truths that contemporary medicine is still learning today, despite tremendous advances in science.
- Ancient societies like Egypt and China used alternative medical practises.
- Mind-boggling concepts may be found in alternative systems like Naturopathy and Ayurveda. The time of day a plant is purchased, prepared, and ingested, for example, has substantial effects. If tulsi leaves are harvested at night, they may turn toxic.



### Healing and Holistic Well-being

- Procedures and therapies that focus on the wellbeing of the entire being, including the body, mind, and soul, can provide holistic well-being.
- The foundation of one's emotional and mental health is one's self, or soul.

### Meditation for Internal Hygiene

- Internal hygiene is important to prevent mental illnesses. If the inner hygiene is hijacked by weaknesses:
- One cannot sleep well
- He/she cannot attain wisdom
- An individual loses his power of discriminating between right and wrong or good and bad
- Many health problems can be solved by natural adjustments in diet and exercise and adopting meditative and prayerful attitude.
- A simple natural meditation can be practiced easily with heartfulness.
- Moreover, natural improvement in self-discipline and lifestyle has multiple cascading benefits.

### Vaccine for Mental and Emotional Health

- What is the vaccine for the mind and emotional heart? Meditation.
- And a simple natural meditation like heartfulness, is practiced easily because it is aided by yogic transmission or Pranahuti.
- The Heartfulness-cleaning process enables us to reduce our daily levels of stress and tension. Most modern diseases are psychosomatic to a large degree. We call them lifestyle diseases, but they can become fatal.
- The natural improvement in self-discipline as a consequence of adopting a meditative and prayerful lifestyle has many cascading benefits.
- One naturally reduces his digital addiction and escapes from excess radiation from electronic devices.
- Heartfulness relaxation and Heartfulness polarity processes are used even by children who are too young to do long-term meditation.
- They find improvement in their educational performance and sports, and also refinement in creativity and joyfulness.
- Meditational approaches are known to thus create significant improvements in mental health and well-being and emotional resilience.
- It reduces anxiety, calms and gives peace, and addresses the root of many problems.



## Chapter 4: Basics of Healthy Lifestyle

- Vegetables, fruits, proteins, healthy fats, fibre, and phytonutrients should all be abundant in a diet.
- Following the half-plate rule and reducing your intake of carbs, sugar, and salt is a simple strategy. Trans fat consumption should also be reduced.

### Half Plate

- Before dining, the entire meal should be pre-plated. It aids in portion control.
- A fantastic illustration of this is the traditional Japanese bento box or Indian thali.
- According to studies, those who plate their meals consume 14% less food than those who get a second and third helping.
- Half of the plate should be made up of veggies with the remaining portion being a side dish of grains or cereals.
- A sufficient amount of proteins should also be provided, such as those found in pulses, dal, nuts, eggs, low-fat dairy, etc.

### How Much to Eat?

- Portion control begins at the serving stage. Put less on the plate or put all that you want at one time rather than going for second.

### What to Eat?

- Eating better is about choosing foods that have a high nutrient density, from fruits and vegetables to whole grains and proteins.

### When to Eat?

- Sleep early, giving your gut the time to break down the food you eat in the most efficient manner possible. Eat between the hours of 7 am and 7 pm, according to the natural circadian rhythm of day and night. In other words, 'Eat during the working hours of your system!'

### How to Eat?

- Eating slowly has a number of benefits. First, the digestive process actually starts in the mouth, so chewing slowly and chewing well improves digestion. Second, it gives the gut the time (about twenty minutes) it needs to register satiation levels.

### Principles of Eating

- It is important to keep up the motivation while on a diet.
- Develop negative associations with undesirable food and do not succumb to fads and or rampant/crash diets.
- Set realistic goals and plan the eating regimen.
- It is important to practice mindful eating and reduce junk and fast food consumption.
- Increase the consumption of fruits and vegetables.
- Avoid unhealthy food, alcohol, and smoking.
- It is important to stick to the body clock.
- It is also necessary to engage in regular physical activity and exercise.
- Individuals should focus on managing stress.
- There should be a thorough physical examination and regular health checkups.



## Chapter 5: Non-Possession – The Gandhian Thought

- In 1930, Gandhiji sent letters to the Satyagraha Ashram once a week while he was being held at Yerwada Central Prison. The letters included a brief analysis of the main Ashram rituals, known as the “eleven vows”:
- |              |                |                         |                           |
|--------------|----------------|-------------------------|---------------------------|
| Truth        | Non-violence   | Chastity (Brahmacharya) | Control of Palate         |
| Non-Stealing | Non-possession | Fearlessness            | Removal of Untouchability |
|              | Bread-labour   | Tolerance               | Swadeshi                  |
- The vows are signs of strength and cannot be practiced by the weak.
  - Once promoted adequately, they can fetch foreign exchange earnings.
  - It can give a competitive global advantage.
  - It preserves India’s rich culture and tradition.
- A handful of Gandhiji’s publications are titled “Guide to Health.” He said that the mind, with the assistance of the ten senses, is responsible for all human activity.
  - There are five senses of action and five senses of perception, respectively.
  - The idea of treating the body as God’s temple is advised.
  - Gandhi’s sustainable and frugal way of living was founded on self-control.

**In the year 1928, Gandhiji formulated certain rules for the ashram. They were:**

1. All ashramites should attend the morning prayer at 4 am.
2. All should eat at the community kitchen.
3. Should spin 160 threads on a daily basis.
4. No servant or labour should be hired for house-work.
5. All adult men should engage themselves in night vigilance.
6. All young and adults should take turn in cleaning toilets.
7. Each person living in the ashram should do the work for the ashram at least for 8 hours daily.
8. One should maintain daily diary and note all the work done during the day.

**Chapter 1: Fostering Water Management for Food Security**

- The increasing pressure on natural resources, particularly land and water poses several challenges to the global food system and its sustainability. Water management will be one of the significant factors in the years to come to ensure water security and achieve SDGs.

**The global food system and its sustainability are facing several challenges due to increasing pressure on natural resources, especially land and water, while in the future the demand for food is set to grow manifold. Indeed, the sustainability of the food system in the future will require much more resource efficient production with prime focus in conservation and management of resources like water. In fact, water management will be one of the most significant factors in the years to come to ensure food security and achieve SDGs. The new India sees efficient water management as key to its future needs to emerge as the world leader.**

**Need for Water Management & Conservation**

- With rising population, climate changes, changes in rainfall patterns, and desertification – water management and conservation have become global priorities.
- India is home to about 18% of the world's population and has only 4% of its water resources. India is one of the most water-stressed countries in the world.
- It is estimated that by 2030, the country's water demand will be twice the available supply which will eventually lead to a ~ 6% loss in the country's GDP.
- With the increasing population, agriculture will need to produce almost 50% more food, livestock fodder and biofuel by 2050 than in 2012 to satisfy the global demand and keep on track to achieve zero hunger.
- In order to address the gap in projected demand and supply, there is a need to bring a shift in farming from intensive to resource-efficient climate-smart farming.

**India's Water Conservation Strategies in Agriculture**

Various initiatives have been taken by the GoI for water conservation in producing maximum yield with minimum water.

Average Annual Rainfall (1985-2015)	105 mm (3880 BCM)
Annual Rainfall (2020)	1283 mm
Mean Annual Natural Run-Off	1999.2 BCM
Total Utilisable Water	1122 BCM
Net Ground Water Availability (2013)	411 BCM
Estimated Utilisable Surface Water Potential	690 BCM
Total Replenishable Ground Water Resources (2013)	432BCM
Ultimate Irrigation Potential	139.9 Mha (From Surface Water= 76 Mha and 64 Mha from Groundwater)



## Estimated Water Demand in India

Sector	Water Demand in BCM (Billion Cubic Meter)								
	Standing Sub-Committee of MOWR			NCIWRD					
	2010	2025	2050	2010		2025		2050	
				Low	High	Low	High	Low	High
Irrigation	688	910	1072	543	557	561	611	628	807
Drinking Water	56	73	102	42	43	55	62	92	111
Industry	12	23	63	37	37	67	67	81	81
Energy	5	15	130	18	19	31	33	63	70
Other	52	72	80	54	54	70	70	111	111
<b>Total</b>	<b>813</b>	<b>1093</b>	<b>1447</b>	<b>694</b>	<b>710</b>	<b>784</b>	<b>843</b>	<b>973</b>	<b>1180</b>

### Pradhan Mantri Krishi Sinchayee Yojana (PMKSY)

- It is a centrally sponsored scheme launched in 2015, with an outlay of Rs 93,068 cr for 2021-26.
- The scheme offers an end-to-end solution for irrigation through source creation, distribution, management, field application and extension activities.
- It was formulated by amalgamating the following schemes-
- Accelerated Irrigation Benefit Programme (AIBP) – Ministry of Jal Shakti, Department of Water Resources, River Development and Ganga Rejuvenation.
- Integrated Watershed Management Programme (IWMP) – Department of Land Resources (DoLR), Ministry of Rural Development.
- On Farm Water Management (OFWM) – Department of Agriculture and Cooperation (DAC).

### Per Drop More Crop (PDMC)

- PDMC was launched in 2015 as a component of PMKSY. From 2022-23 PDMC is being implemented under Rashtriya Krishi Vikas Yojana (RKVY).
- PDMC focuses on micro-irrigation technologies like drip and sprinkler irrigation systems.
- Under this scheme, GoI provides subsidies to small and marginal farmers @ 55% of the indicative unit cost and @ 45% to other farmers.

### Sahi Fasal Campaign

- The Sahi Fasal campaign is a component of the National Water Mission, launched in 2019 by the Ministry of Jal Shakti.
- The “Sahi Fasal” campaign was launched to nudge farmers in the water-stressed areas to grow crops which are not water intensive, but use water very efficiently, and are economically remunerative; are healthy and nutritious; suited to the agro-climatic-hydro characteristics of the area; and are environmentally friendly.

### Bhartiya Prakratik Krishi Padhati (BPKP)

- Bharatiya Prakritik Krishi Paddhati (BPKP) is a sub-mission under the Paramparagat Krishi Vikas Yojana (PKVY), which falls within the umbrella of the National Mission on Sustainable Agriculture (NMSA).
- The scheme has a total outlay of Rs 4645.69 cr. for the period of 6 years (2019-20 to 2024-25).
- BPKP promotes natural farming – a chemical-free, traditional farming-based diversified farming system that integrates crops, trees and livestock with functional biodiversity.
- The scheme aims at minimising the cost of cultivation, recreation of soil ecosystem and ensuring environmental sustainability.
- The Ministry of Agriculture and Farmers’ Welfare has made concerted efforts to encourage the diversification of agricultural and horticultural crops as per the local need through various ongoing schemes like – the National Food Security Mission (NFSM), Rashtriya Krishi Vikas Yojana (RKVY), Mission for Integrated Development of Horticulture (MIDH), National Mission on Oilseeds and Oil Palm (NMOOP), National Mission for Sustainable Agriculture (NMSA) and Rainfed Area Development (RAD).

### Way Forward

- Water being a state subject, requires cooperation to harness steps for augmentation, conservation and efficient management of water resources across states.
- Ecosystem services and incentives should be considered to encourage efficient use of water resources.

## Chapter 2: Water Conservation through Community Planning

The comprehensive development of fundamental infrastructure is necessary to realise the goals of inclusive growth with fairness and social justice. To ensure a healthy and economically productive society and become a water-secure country, it is crucial to organise an appropriate, timely, and inexpensive water supply. Only 6% of the nation's annual 1,200 mm of rainfall is stored, therefore saving and conserving water is crucial to supplying the nation's water demands.

### Community Participation in Water Conservation-

As per the constitution of India, 'water' is a state subject. Therefore, steps to augment, conserve and manage water resources have remained the primary responsibility of the respective states. States' water conservation efforts are supported through various central government schemes with required provisions of technical and financial assistance.

**Civic participation in the management processes of any public development endeavour results in better outcomes.**  
**Water Conservation Initiatives by the States:**

#### 1. Neeru-Chettu

Implementing State – Andhra Pradesh

- It is aimed at collective participation and the spread of awareness to make the state 'drought proof' through better water conservation.
- The activity involves rejuvenating and re-vitalising water resources through the desilting of tanks and feeder channels, etc.

#### 2. Jal Jeevan Hariyali

Implementing State – Bihar

- It is aimed at encouraging farmers to participate in water conservation efforts of the government and to sensitise them on the use of alternative crops, organic farming, drip irrigation and other technologies with less dependence on irrigation.
- It involves the identification, restoration and renovation of all public storage structures- canals, ponds, etc.

#### 3. Sujalam Sufalam Jal Sanchay Abhiyan

Implementing State – Gujarat

- It is a Public Private Partnership (PPP) programme and the government's contribution is 60% of the work expenditure.
- The project involves deepening of the water bodies before the arrival of the monsoon to enhance storage.

#### 4. Jal Hi Jeevan Hai

Implementing State – Haryana

- It encourages farmers to adopt crop diversification and sow crops which need less water like maize, arhar, etc.

#### 5. Pani Panchayat

Implementing State – Odisha

- It aims to ensure optimum utilisation of water as well as improving agriculture production.

SN	State	Name of Initiative	Programme Activity
1	Andhra Pradesh	Neeru-Chettu	Rejuvenating and revitalising natural resources. De-silting of tanks and feeder channels, etc., are taken up, additional water storage is created. Aimed at collective participation and spread of awareness to make the State 'drought proof' through better Water Conservation.
2	Bihar	Jal Jeevan Hariyali	Identification, restoration, and renovation of all public water storage structures – ponds / canal / pines, etc. Construction of check dams and other water harvesting structures in small rivers / drains and water storage areas of hilly areas. The objective is to encourage farmers to participate in water conservation initiatives of the government and to get sensitised on the use of alternative crops, drip irrigation, organic farming, and other new technologies with less dependence on irrigation.
3	Gujarat	Sujalam Sufalam Jal Sanchay Abhiyan	Deepening water bodies in the state before monsoon arrives to increase storage of rainwater to be used during times of scarcity. It is a Public Private Partnership programme and government contribution is 60 per cent of the work expenditure.
4	Haryana	Jal Hi Jeevan Hai	Encouraging farmers to adopt crop diversification and sow crops which require less water like Maize, Arhar, etc., instead of water guzzling crops such as paddy so as to conserve water.
5	Odisha	Pani Panchayat	Ensuring voluntary activity of group of farmers engaged in the collective management (harvesting and distribution) of surface water and groundwater (wells and percolation tanks). Objective is to ensure optimum utilisation of water as well as improving agricultural production.
6	Maharashtra	Jalyukt Shivar Abhiyan	Deepening and widening of water streams, construction of cement and earthen stop-dams, works on nullahs and digging of farm ponds. Objective is to make Maharashtra drought-free by making 5,000 villages free of water scarcity each year.
7	Rajasthan	Mukhya Mantri Jal Swawalamban Abhiyan	Extending conservation efforts to manage rainfall, runoff, groundwater & in-situ soil moisture. Through convergence of schemes of various departments, works are executed through people's participation by motivating villagers & beneficiaries.
8	Telangana	Mission Kakatiya	Reclamation of water tanks by restoring minor irrigation sources. Aims at spreading minor irrigation in the state with community participation for sustainable water security.

## 6. Jalyukht Shivar Abhiyan

Implementing State – Maharashtra

- The aim is to make Maharashtra drought-free by making 5000 villages free of water scarcity every year.
- It involves the deepening and widening of water streams, the construction of cement and earthen stop dams, etc.

## 7. Mukhya Mantri Jal Swawalamban Abhiyan

Implementing State – Rajasthan

- Through the convergence of schemes of various departments, works are executed through people's participation by motivating villagers and beneficiaries.
- The conservation efforts include managing rainfall, run-off, groundwater and in-situ soil moisture.

## 8. Mission Kakatiya

Implementing State – Telangana

- The initiative aims at spreading minor irrigation in the state with community participation for sustainable water security.

## Water Conservation Initiatives of the Union Government:

- India has about 141 million hectares of net-sown area, out of which about 65 million hectares (45%) are currently covered under irrigation of any source. India highly depends on rainfall making cultivation in unirrigated areas a risk-laden, less remunerative and less productive profession. Assured irrigation encourages farmers to invest more in farming technology and inputs, leading to an increase in income and productivity.
- Pradhan Mantri Krishi Sinchayee Yojana aims to ensure sustainable access to some means of irrigation to all agricultural farms in the country through efficient management of water resources and by propagating the tagline – Per Drop More Crop.

The various components of PMKSY that need adequate community planning and participation during the implementation phase are:

- Har Khet Ko Pani.
- Watershed Development.
- Per Drop More Crop.
- Jal Shakti Abhiyan – This mission is implemented to improve water availability, including groundwater conditions in the water-stressed blocks of 256 districts in India.
- Atal Bhujal Yojana – It aims at sustainable management of groundwater with community participation in identified over-exploited and water-stressed areas of Gujarat, Rajasthan, Haryana, Uttar Pradesh, Madhya Pradesh, Maharashtra and Karnataka.
- The Ministry of Jal Shakti has also taken other important measures for water conservation through active community participation – National Aquifer Mapping and Management (NAQUIM) Programme, Rain Area Development Programme (RADP), National Perspective Plan, Catch the Rain and Sahi Fasal campaigns.

SN	PMKSY Components	Programme Activity
1	Har Khet ko Pani	Create new water sources through Minor Irrigation (surface and groundwater); Repair, restoration and renovation of water bodies; Construct rain water harvesting structures; Command area development, strengthening and creation of distribution network from source to the farm; Create and rejuvenate traditional water storage systems [like Jal Mandir (Gujarat); Khatri, Kuhl (H.P.); Zabo (Nagaland); Eri, Ooranis (T.N.); Dongs (Assam); Katas, Bandhas (Odisha and M.P.) etc.] at feasible locations.
2	Watershed Development	Create water harvesting structures viz. check dams, nala-bund, farm ponds, tanks, etc.; Ridge area treatment, drainage line treatment, soil and moisture conservation, nursery raising, afforestation, horticulture, pasture development, livelihood activities for the asset-less persons; Effective rainfall management like field bunding, contour bunding/trenching, staggered trenching, land levelling, mulching, etc.
3	Per Drop More Crop	Programme management, preparation of State/District Irrigation Plan, approval of annual action plan, Monitoring, etc.; Promote efficient water conveyance and precision water application devices like drips, sprinklers, pivots, rain-guns in the farm; Construct micro irrigation structures; Secondary storage structures at tail end of canal system to store water when available in abundance (rainy season) or from perennial sources like streams for use during dry periods through effective on-farm water management.
4	MGNREGA	Create water harvesting structures on individual lands of vulnerable sections, creation of new irrigation sources, upgradation/desilting of traditional water bodies, water conservation works, etc.; De-siltation of canal & distribution system, deepening and desiltation of existing water bodies, strengthening of bunds/embankments, etc.



## Community Engagement in MGNREGA Watershed Development Works

Type of Watershed Development Works	Engagement of the Community
<ul style="list-style-type: none"> <li>Contour trenching for water conservation in plantations and grassland development.</li> <li>Loose boulder bunding by erecting dry stone walls across the hill slopes at pre-determined spacing for developing land for cultivation.</li> <li>Spring-shed development in north eastern States to revive springs and protect these against drying up during dry season.</li> <li>Village ponds- excavation and renovation of existing ponds to increase water storage space.</li> <li>Bench terracing to use the hill slopes for crop production on sustainable basis.</li> <li>Gabion structures of stone and wire dams across drainage lines to address soil erosion issues.</li> </ul>	<ul style="list-style-type: none"> <li>Intensive participatory planning exercise is adopted to prepare watershed development plans with active involvement of villagers.</li> <li>Identification of workable watershed boundaries [with around 500-1000 hectares of area] by referring to watershed atlas available with the States concerned.</li> <li>Carrying out Baseline/benchmark Surveys viz. climate, soil types, fertility, rainfall pattern, runoff volume, land-use pattern, vegetation to make the plan outcome-oriented.</li> <li>Active participation of community makes the programme community-driven and community managed/owned.</li> <li>Adoption of Participatory Rural Appraisal which combines various tools like social mapping, resource mapping, seasonal mapping, transect walk, focus group discussions enables community to express and analyse their own situation, clearly delineating location-specific water needs and priorities.</li> </ul>

### Measures for the Success of Water Conservation Efforts :

- The 73rd Constitutional Amendment empowers Gram Panchayats to plan and manage rural water supply and sanitation systems.
- The effective planning and implementation of water conservation-related schemes demand active community engagement through PRIs (Panchayati Raj Institutions), Self Help Groups (SHGs), Farmer's Groups and Cooperatives. The community through PRIs should take up the responsibility of being Programme Implementing Agencies (PIAs).

### The community should ensure the following for the success of water conservation efforts in rural areas –

- Preparation of Water Security Plan, Irrigation Plan and Village Action Plan.
- Discuss and deliberate on the sustainability of water schemes, and explore new revenue resources for water conservation systems.
- Preparation of water reserve audit, and water safety plan to ensure recharge, storage and availability of water and to meet issues relating to water quality usage.
- Promoting timely execution of projects and utilisation of funds.
- Arrange training and capacity building programmes on water collection, storage, usage etc for grass-root workers.

**Conclusion –** The water conservation programmes would be successful in achieving their objectives only if the community and end beneficiaries are involved in various stages of programme implementation.

## Chapter 3: Community Engagement in MGNREGA Watershed Development Works

- In response to the global water crisis, the United Nations has established a target under its 2030 Agenda for Sustainable Development which is to ensure that everyone has access to clean water and sanitation (SDG 6). However, the United Nations World Water Development Report, 2019 indicates that almost two-thirds of the world's population suffer from severe water scarcity for at least one month every year.



- Despite having abundant rainfall, India faces frequent droughts, floods and water scarcity due to inadequate water management practices and rapid urbanisation.
- Tackling the water crisis requires a concerted effort from various stakeholders, including government, civic bodies, administration, educational institutions, NGOs, media as well as society.
- There is a need for structured long-term campaigns to build awareness and educate people and also to incentivise and reward them to save every drop of water.

## National Water Mission (NWM)

- The National Water Mission is one of the eight missions under the National Action Plan on Climate Change (NAPCC).
- The main objective of NWM is the conservation of water, minimising wastage and ensuring its more equitable distribution both across and within states through integrated water resources management and development.
- One of the five goals of the National Water Mission is to promote citizen and state actions for water conservation, augmentation and preservation.
- One of the strategies of NWM under Goal IV is to incentivise organisations or companies through awards for water conservation and efficient use of water resources. The annual NWM Water Awards recognise excellence in water conservation, efficient water use and sustainable water management practices.
- Water Talk – The NWM organises lecture series called ‘Water Talk’ with an objective to facilitate the exchange of information pertaining to water-related topics. The Water Talk series takes place on the third Friday of every month and features presentations from experts and practitioners in the field.

### ‘Catch the Rain’ campaign

- The “Catch the Rain” campaign is being run by the NWM.
- This campaign was launched on 22nd March 2021 on the occasion of World Water Day.
- The campaign aims to encourage the states and stakeholders to create and maintain appropriate rainwater harvesting structures (RWHS), suitable to the soil strata and climatic conditions of the area, with people’s participation with the theme ‘Catch the rain, where it falls, when it falls’.
- The campaign involves the active participation of the local community in the implementation of measures to enhance the storage capacity of water bodies.

### Strategies to Educate People :

Through education and awareness-building campaigns, individuals can be empowered to take responsibility for their water consumption and ensure that every drop of this precious resource is conserved. In the past, many mass awareness campaigns were launched on the need for the conservation of water like media campaigns, puppet shows, street theatres, jal yatras etc. Doordarshan, Akashwani and other government media platforms have been continuously utilised to create awareness amongst the masses. The other measures which could be utilised to make water conservation a mass movement include-

- Social Media – can be used to directly reach out to people in real-time and proactively engage with them.
- Conventional Media – using the mediums like TV, newspapers, and radio as these have vast footprints across the country.
- Educational Institutions.
- Engaging Communities – organising community programmes like seminars, workshops etc.
- Incentives and Rewards – to encourage people to conserve water, incentives like tax rebates, and discounts can be offered. This can be done at the local level with funding support from the Centre or State governments.
- Involving Private Sector – There are already some private organisations which are running campaigns for the conservation of water.
- Engaging with eminent personalities – Celebrity involvement can be sought to attract public attention and promote water conservation initiatives.

## Chapter 4: Making Villages Water Sufficient

- Localisation of Sustainable Development Goals (LSDGs) through PRIs (Panchayati Raj Institutions) serves as a plan towards achieving Sustainable Development Goals (SDGs).

### The 17 UN- SDGs have been remapped into 9 broad themes:

- Theme 1 – Poverty free and enhanced livelihood villages.
- Theme 2 – Healthy village.
- Theme 3 – Child-friendly village.
- Theme 4 – Water sufficient village.

- Theme 5 – Clean and green village.
- Theme 6 – Self-sufficient infrastructure in the village.
- Theme 7 – Socially secured village.
- Theme 8 – Village with good governance.
- Theme 9 – Engendered Development in village.

Sl No.	Goals
1.	Providing access to clean Water to all households and public buildings in the villages by 2024
2.	Provide access to Sanitation in the villages
3.	Achieve ODF Sustainability
4.	Grey Water management
5.	Per capita availability of water in villages
6.	Construction of rainwater harvesting and recharge works
7.	Safeguarding of water bodies
8.	Constitution of Village Water and Sanitation Committees (VWSCs) in each Gram Panchayats
9.	Water efficient Agricultural practices

### Water Sufficient Village

- ❖ Theme 4 of the LSDGs- Water Sufficient Village is related to many other SDGs. For example, lack of adequate water for irrigation leads to low income for marginal farmers and landless labourers dependent on agriculture and it is likely that their livelihood will fall below the poverty line (SDG 1-Zero Poverty), adequate water for irrigation will increase the agricultural productivity (SDG 2- Zero Hunger) and so on.
- ❖ Theme 4 – Water Sufficient Village is multi-dimensional and directly related to health, education, gender equality, sustainable and efficient use of natural resources etc.
- Under Theme 4, there are 9 sub-goals that have been set with 25 Modified GP (Gram Panchayat) Level Indicator to assess, analyse and monitor the progress.
  - Providing access to clean water to all village households by 2024.
  - Provide access to sanitation in the villages.
  - Achieve ODF (Open Defecation Free) sustainability.
  - Grey water management.
  - Per capita availability of water in villages.
  - Construction of rainwater harvesting and recharge works.
  - Safeguarding of water bodies.
  - Constitution of Village Water and Sanitation Committees (VWSCs) in each Gram Panchayat.
  - Water efficient agricultural practices.
- A robust plan is needed to ensure that resources (human, knowledge, financial and administrative) reach the endpoint (village, farmer or family). PRIs must have basic knowledge of all the ongoing schemes and the ability to develop comprehensive action plans.
- To achieve water sufficient village, the GP must explore resources from many schemes like 15th Finance Commission Funds, Jal Jeevan Mission (JJM), MGNREGA, Swachh Bharat Mission Gramin (SBM-G), National Rural Drinking Water Programme (NRDWP), Pradhan Mantri Krishi Sinchayee Yojana (PMKSY) etc.

### Learning from the Good Initiatives and Practices :

- Many results-yielding initiatives are in operation in different parts of the country for the restoration, conservation and sustainable use of water resources. Such initiatives need to be documented and attempts should be made to replicate with any necessary customisation.
- Kerala is the first state in the country to prepare a Water Budget based on local self-government bodies by calculating water availability and consumption. The water budget puts forward scientific methods for the conservation of water resources and also aims at creating awareness among the public about the need for water conservation.
- In Telangana state, the Mission Bhagiratha scheme is implemented in all the villages for providing safe and sustainable drinking water to all households. Also, the Mission Kakatiya scheme was implemented to restore the irrigation tanks to their full capacity and a number of water conservation works like the construction of check demand, other harvesting structures, desilting of feeder and field channels etc are taken up under MGNREGA.

Conclusion – Local Institutions such as Panchayats play a major role in achieving Water Sufficient Village. Further, all water-related issues are to be mainstreamed in the Gram Panchayat Development Plan (GPDP). The participation of people, community-led management, training and capacity building of PR functionaries and officials of various line departments will bring in the desired results in terms of water-sufficient villages.



## Chapter 5: Water Use Efficiency Ensuring Water Sustainability

'Water' is at the very core of the 2030 Agenda for Sustainable Development. Sustainable Development Goals – Target 6.4 addresses water use efficiency and water stress. SDG target 6.2 is: 'By 2030, substantially increase water use efficiency across all sectors and ensure sustainable withdrawals and supply of freshwater to address water scarcity and substantially reduce the number of people suffering from water scarcity'.

### Water Use Efficiency:

- Water Use Efficiency is the ratio between effective water use and actual water withdrawal.
- Enhancing water use efficiency in every sector of water use (agriculture, drinking, domestic etc) is very important for sustaining life faced with the challenges posed by climate change in the water sector.

### Water Use Efficiency in Agriculture:

- India is an agrarian country and agriculture is the source of livelihood for about 58% of the country's population.
- Water Use Efficiency (WUE) in irrigation is the percentage of the irrigation water consumed by the crop of an irrigated farm, field and project to the water delivered from the source. Some water is lost due to conveyance, distribution and application in the field.
- In India, the agriculture sector is the largest consumer of water resources, therefore even a small percentage saving of water in this sector will have a large impact on the availability of water for drinking and domestic purposes.

### Methods for Improving Water Use Efficiency in Agriculture:

#### 1. Micro Irrigation

- The WUE in micro-irrigation including drip irrigation is as high as 80-95% in comparison to only 30-50% in conventional flood irrigation.
- The micro-irrigation techniques also help in reducing water logging, fertiliser usage, labour expenses and other input costs and in enhancing agricultural productivity and farmers' income besides sustaining soil health.

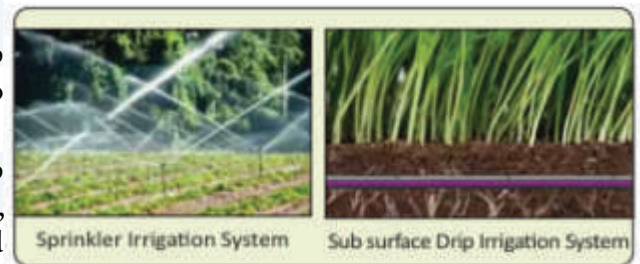

#### 2. Mulching

- Mulching helps in increasing WUE by controlling water losses by evaporation from the plant root zone.
- A mulch is a material spread on the top of the soil – plastic sheets, organic material.
- There is about 10% water saving from the use of mulch materials in agriculture.

#### 3. Drought- Tolerant Crops

- Growing crops that are appropriate to the climate of the region also helps in getting more crops per drop.
- The ICAR has developed several drought-tolerant short-duration crop varieties that suit different agro-climatic regions of the country for judicious use of water.



### Other measures to increase water use efficiency include:

- Reduce conveyance losses by lining channels or preferably, by using closed conduits.
- Avoiding mid-day sprinkling reduces evaporation.
- Reduce run-off and percolation losses due to over-irrigation.
- Select the most suitable and marketable crops for the region.
- Use appropriate insect, disease and parasite control.

- Apply manures and green manures where possible and fertilise effectively.
- Apply weed control measures.
- Practice soil conservation for long-term sustainability.
- Irrigate in the exact amounts to prevent water deficits, taking into account weather conditions and crop growth stages.

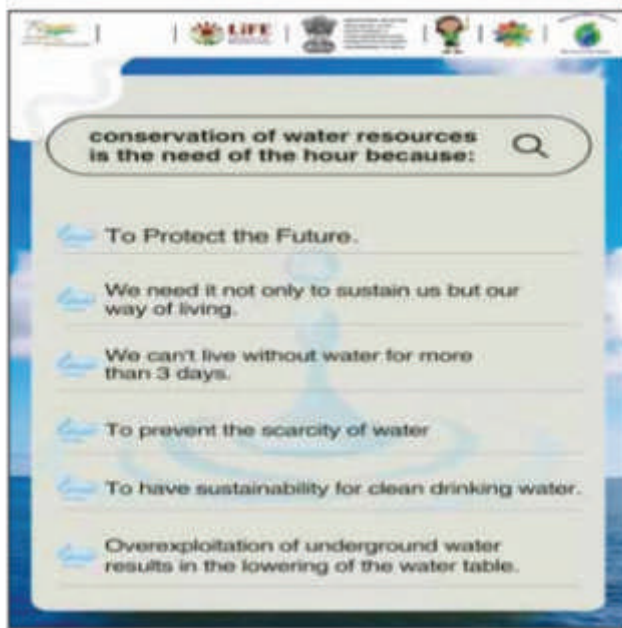

#### Initiatives to increase WUE in the Agriculture Sector:

- PMKSY (Pradhan Mantri Krishi Sinchayee Yojana)
- AIBP (Accelerated Irrigation Benefit Programme) – The GoI launched AIBP during 1996-97 to provide Central Loan Assistance (CLA) to major and medium irrigation projects that were in an advanced stage of completion to achieve the targeted potential, ultimately resulting in saving water and improving efficiency.
- During 2015-16 AIBP was integrated with PMKSY.
- Command Area Development and Water Management (CADWM)– The GoI launched CADWM during 1974-75 to bridge the gap between IPC (Irrigation Potential Created) and IPU (Irrigation Potential Utilised).
- With the launch of PMKSY, CADWM was included under the Har Khet Ko Pani component of the PMKSY.
- Har Khet Ko Pani (HKKP) – HKKP is a component under PMKSY and aims at ensuring water to every farm through assured irrigation.
- Per Drop More Crop – ensures more productivity through micro-irrigation (also a component of PMKSY).
- National Water Mission (NWM) – National Water Mission was launched in June 2008 with five goals. One of the most important goals of NWM is to improve the WUE by at least 20%. To realise this goal, research in the area of increasing WUE in agriculture, industry and domestic usage is one of the important strategies.
- Bureau of Water Use Efficiency (BWUE)- The BWUE was established under the National Water Mission in October 2022 to achieve the target of improvement in WUE by 20%.
- BWUE is a facilitator for the promotion of improving WUE across various sectors- agriculture, industry, power generation etc.

#### Water Use Efficiency (WUE) in Industrial Sector:

- Recent studies have revealed that industrial water demand will quadruple between 2005 and 2030, putting further pressure on the already over-allocated water resources of the country.
- The water scarcity has led to shut down of at least India's 20 largest thermal utilities between 2013 & 2016, taking a total financial toll of USD 1.4 billion. It is therefore important for companies to elevate water resource management above the realm of corporate social responsibilities.

### Initiatives to increase WUE in Industrial Sector:

The National Water Mission has awarded a benchmarking study to TERI regarding 'Benchmarking Industrial Water Use to Assist Policy for Enhancing Industrial WUE in India'.

- In phase 1, the study would focus on two industrial sectors – thermal power plants and textile industries.
- In phase 2, water audit in pulp and paper, and steel industries would be taken up.

### Initiatives to increase WUE in the domestic sector:

- The National Water Mission has recommended to BIS take steps to issue standards for water-efficient plumbing products.
- AMRUT Mission- It aims at sustainable management of water in urban areas.

## Chapter 6: 2023: Year of International Water Commitments and What it Means for Rural India

- The year 2023 is an important year nationally and internationally for the water-related goals of the world.
- In 2017, the United Nations adopted a resolution declaring 2018 – 2028 as the International Decade for Action on Water for Sustainable Development. The year 2023 is the mid-year of the decade for action on water and also for SDGs.
- The IPCC Sixth Assessment Report, IPCC Report 2021, highlights that the water cycle is more sensitive to global warming, causing an increase in droughts, floods and cyclones with a one-degree temperature rise. These issues impact nearly 40% of the global population.
- As per the United Nations Office for Disaster Risk Reduction estimates in 2019, India suffered losses of Rs 5.61 lakh cr. due to extreme climate events in the past two decades.
- As per the report by the Council on Energy, Environment and Water (CEEW) in 2021, more than 75% of India's districts are extreme event hotspots, and more than 80% of India's population resides in districts highly vulnerable to extreme hydromet disasters like droughts, floods and cyclones.
- Water scarcity, water quality degradation, infrastructure damage and increased spread of waterborne diseases are some of the consequences of climate change.

### Water Matters for Rural India

- 53% of districts in India are rural (Census 2011), out of which 37% are vulnerable to the impacts of extreme hydromet disasters. Thus, it is important to ensure water security in rural areas to mitigate the impacts of droughts, floods and cyclones.
- Agriculture and WASH (water, sanitation and hygiene) are the two sectors where the demand for water is highest. Agriculture accounts for a larger share of water demand (almost 80%), however, WASH is also important from the perspective of public health.
- There is an increased dependence on groundwater for meeting water demands. As per Central Ground Water Board (CGWB) Analysis 2022, about 30% of the assessment units in the country are semi-critical, critical or over-exploited. Considering more than 80% of the rural water supply schemes are based on groundwater sources, non-regulation of groundwater can be a matter of concern in future.

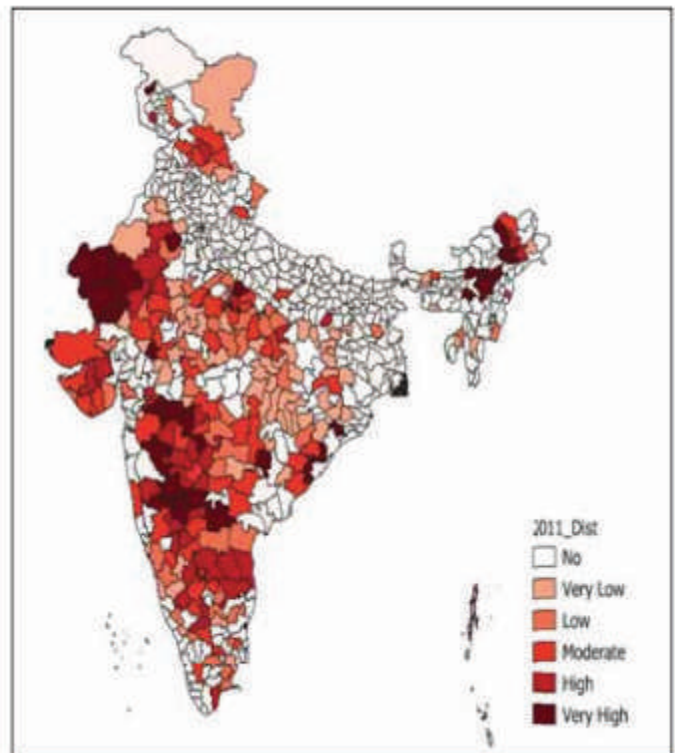

### Major International Commitments and Outcomes

#### G20 (Group of Twenty)

- Under India's G20 Presidency, a dedicated global water dialogue is being held as a part of the Environment and Climate Sustainability Working Group (ECSWG). It focuses on achieving sustainable water resources management in alignment with SDG-6 by 2030.



- During the second G20 ECSWG meeting, the Ministry of Jal Shakti emphasised the importance of climate-sensitive development for ensuring water security, while highlighting India's two flagship missions – Jal Jeevan Mission and Swachh Bharat Mission.
- The intended outcomes of these dialogues include –
- Universal access to safe drinking water and sanitation services.
- Groundwater management involves local stakeholders in groundwater recharge and its efficient use.
- Climate resilient water infrastructure with improved disaster risk reduction.

#### United Nations Water Conference (UNWC)

- The UNWC, 2023 was co-hosted by Tajikistan and Netherlands in March 2023 at Un Headquarters in New York.
- The main outcome of the conference is a document on voluntary and non-binding commitments to accelerate progress to meet the global water and sanitation-related goals and targets in the second half of the Water Action Decade and 2030 Agenda. About 700 commitments were made towards a water-secure world.
- India under the action agenda has allocated USD 50 billion to provide safe and adequate drinking water to all rural households by 2024, which is much before 2030.

#### Conference of Parties (COP):

- The COP is an annual meeting organised by the UNFCCC (United Nations Framework Convention on Climate Change) where countries come together and discuss and address climate change issues.
- The Water Action Track was launched at COP25 in 2019 to increase action on climate change adaptation and mitigation, with a particular focus on SDG 6.
- At COP26, the Water Pavilion was established which provided a platform for stakeholders to share knowledge and experiences on water management in the face of climate change.
- In 2022, water and sanitation were also introduced for the first time in agendas



#### Way Forward

- The way forward for India to meet SDG 6 targets should be to synergise and leverage its existing programmes and commitments. India can leverage the collective knowledge and experiences gained at international forums like COP, UN Summits, G20 etc to strengthen the existing strategies to address climate change and build resilience in the water sector.

# ലക്ഷ്യമുണ്ടെങ്കിൽ മാർഗ്ഗവുമുണ്ട്.

Entri യും Thakshasila യും കൈകോർക്കുന്നു.

No.1 സിവിൽ സർവ്വീസ് കോച്ചിങ്ങ്. ഇനി വീട്ടിലിരുന്നു തന്നെ!

Our  
**CSE 2022**  
Toppers

DILIP K KAINIKKARA (AIR 21)	ALFRED O V (AIR 57)	KIRAN P B (AIR 100)	ROJA S RAJAN (AIR 108)	ARJUN UNNIKRISHNAN (AIR 145)		
S GAUTHAMRAJ (AIR 210)	LALITH KUMAR V (AIR 211)	HRIDYA S VIJAYAN (AIR 317)	JOHN GEORGE DCOUTHO (AIR 428)	ANJALI BHAVANA (AIR 463)	APARNA O (AIR 475)	PRAPANJ R (AIR 523)

Our  
**CSE 2021**  
Toppers

APARNA M B (AIR 62)	VEENA S SUTHAN (AIR 57)	SOORAJ BEN K R (AIR 1)				
ARYA R NAIR (AIR 113)	MALINI S (AIR 135)	MINNU (AIR 150)	SREETHU S S (AIR 163)	THASNI SHANAVAS (AIR 250)	ALEX ABRAHAM P J (AIR 299)	ALFRED O V (AIR 310)
S GAUTHAMRAJ (AIR 311)	GOKUL S (AIR 357)	ANEEZ S (AIR 403)	HARIPRSAD K K (AIR 421)	SHWETA K SUGATHAN (AIR 456)	SABEEL POOVAKUNDIL (AIR 470)	AJESH (AIR 475)

**Course features**

Delhi model intensive coaching | Live sessions | Study plan | Prelims test series  
 Writing practice for Mains | Special current affairs classes | Follow-up sessions  
 Doubt clearance | WhatsApp group | 600+ hours of recorded classes (Prelims/Mains)

**8137 095 777**

SCAN HERE





**Scan for Something  
Exciting!**

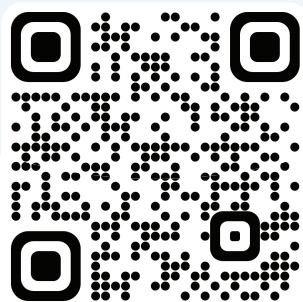

Trusted by over 1 crore students